

# Current-Mode PWM Controllers with Integrated Startup Circuit for Isolated Power Supplies

## General Description

The MAX5014/MAX5015 integrate all the building blocks necessary for implementing DC-DC fixed-frequency isolated power supplies. These devices are current-mode controllers with an integrated high-voltage startup circuit suitable for isolated telecom/industrial voltage range power supplies. Current-mode control with leading-edge blanking simplifies control-loop design and internal ramp compensation circuitry stabilizes the current loop when operating at duty cycles above 50% (MAX5014). The MAX5014 allows 85% operating duty cycle and could be used to implement flyback converters, whereas the MAX5015 limits the operating duty cycle to less than 50% and can be used in single-ended forward converters. A high-voltage startup circuit allows these devices to draw power directly from the 18V to 110V input supply during startup. The switching frequency is internally trimmed to 275kHz  $\pm$ 10%, thus reducing magnetics and filter component costs.

The MAX5014/MAX5015 are available in 8-pin SO packages. An evaluation kit (MAX5015EVKIT) is also available.

**Warning:** The MAX5014/MAX5015 are designed to operate with high voltages. Exercise caution.

## Applications

Telecom Power Supplies  
Industrial Power Supplies  
Networking Power Supplies  
Isolated Power Supplies

## Pin Configuration

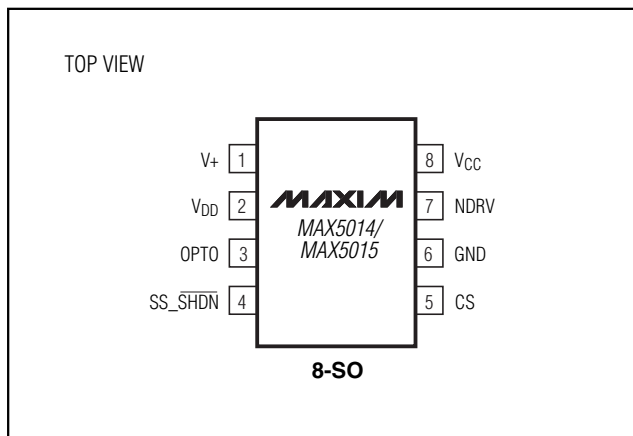

## Features

- ◆ Wide Input Range: (18V to 110V) or (13V to 36V)
- ◆ Current-Mode Control
- ◆ Leading-Edge Blanking
- ◆ Internally Trimmed 275kHz  $\pm$ 10% Oscillator
- ◆ Low External Component Count
- ◆ Soft-Start
- ◆ High-Voltage Startup Circuit
- ◆ Pulse-by-Pulse Current Limiting
- ◆ Thermal Shutdown
- ◆ SO-8 Package

## Ordering Information

PART	TEMP. RANGE	PIN-PACKAGE
MAX5014CSA*	0°C to +70°C	8-SO
MAX5014ESA*	-40°C to +85°C	8-SO
MAX5015CSA*	0°C to +70°C	8-SO
MAX5015ESA*	-40°C to +85°C	8-SO

\*See Selector Guide at end of data sheet.

## Typical Operating Circuit

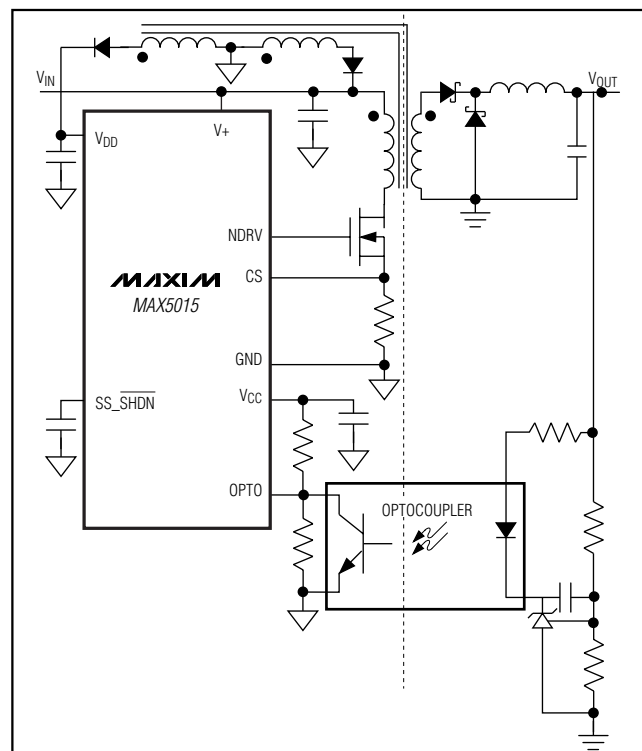

# Current-Mode PWM Controllers with Integrated Startup Circuit for Isolated Power Supplies

## ABSOLUTE MAXIMUM RATINGS

V+ to GND .....	-0.3V to +120V	Continuous Power Dissipation (T <sub>A</sub> = +70°C)	
V <sub>DD</sub> to GND.....	-0.3V to +40V	8-Pin SO (derate 5.88mW/°C above +70°C) .....	471mW
V <sub>CC</sub> to GND.....	-0.3V to +12.5V	Operating Temperature Range.....	-40°C to +85°C
OPTO, NDRV, SS_ŠHDN, CS to GND .....	-0.3V to V <sub>CC</sub> + 0.3V	Storage Temperature Range.....	-65°C to +150°C
V <sub>DD</sub> and V <sub>CC</sub> Current .....	20mA	Lead Temperature (soldering, 10s) .....	+300°C
NDRV Current Continuous.....	25mA		
NDRV Current for Less than 1µs.....	±1A		

Stresses beyond those listed under "Absolute Maximum Ratings" may cause permanent damage to the device. These are stress ratings only, and functional operation of the device at these or any other conditions beyond those indicated in the operational sections of the specifications is not implied. Exposure to absolute maximum rating conditions for extended periods may affect device reliability.

## ELECTRICAL CHARACTERISTICS

(V<sub>DD</sub> = 13V, a 10µF capacitor connects V<sub>CC</sub> to GND, V<sub>CS</sub> = 0, V+ = 48V, 0.1µF capacitor connected to SS\_ŠHDN, NDRV = open circuit, OPTO = GND, T<sub>A</sub> = -40°C to +85°C, unless otherwise noted. Typical values are at T<sub>A</sub> = +25°C.)

PARAMETER	SYMBOL	CONDITIONS	MIN	TYP	MAX	UNITS
<b>SUPPLY CURRENT</b>						
V+ Supply Current	I <sub>V+(NS)</sub>	V <sub>DD</sub> = 0, V+ = 110V, driver not switching		0.85	1.3	mA
	I <sub>V+(S)</sub>	V+ = 110V, V <sub>DD</sub> = 0, V <sub>OPTO</sub> = 4V, driver switching		1.4	2.6	
V+ Supply Current After Startup		V+ = 110V, V <sub>DD</sub> = 13V, V <sub>OPTO</sub> = 4V		11		µA
V <sub>DD</sub> Supply Current	I <sub>VDD(NS)</sub>	V <sub>DD</sub> = 36V, driver not switching		0.9	1.3	mA
	I <sub>VDD(S)</sub>	V <sub>DD</sub> = 36V, driver switching, V <sub>OPTO</sub> = 4V		1.9	2.7	
V+ Shutdown Current		V <sub>SS_ŠHDN</sub> = 0, V+ = 110V		190	290	µA
V <sub>DD</sub> Shutdown Current		V <sub>SS_ŠHDN</sub> = 0		8	20	µA
<b>PREREGULATOR/STARTUP</b>						
V+ Input Voltage			18		110	V
V <sub>DD</sub> Supply Voltage			13		36	V
<b>INTERNAL REGULATORS (V<sub>CC</sub>)</b>						
V <sub>CC</sub> Output Voltage		Powered from V+, I <sub>CC</sub> = 7.5mA, V <sub>DD</sub> = 0	7.5	9.8	12	V
		Powered from V <sub>DD</sub> , I <sub>CC</sub> = 7.5mA	9.0	10.0	11.0	V
V <sub>CC</sub> Undervoltage Lockout	V <sub>CC_UVLO</sub>	V <sub>CC</sub> falling		6.6		V
<b>OUTPUT DRIVER</b>						
Peak Source Current		V <sub>CC</sub> = 11V, (externally forced)		570		mA
Peak Sink Current		V <sub>CC</sub> = 11V, (externally forced)		1000		mA
NRDV High-Side Driver Resistance	R <sub>OH</sub>	V <sub>CC</sub> = 11V, externally forced, NDRV sourcing 50mA		4	12	Ω
NDRV Low Side Driver Resistance	R <sub>OL</sub>	V <sub>CC</sub> = 11V, externally forced, NDRV sinking 50mA		1.6	4	Ω
<b>PWM COMPARATOR</b>						
OPTO Input Bias Current		V <sub>OPTO</sub> = V <sub>SS_ŠHDN</sub>	-1.00		1.00	µA
OPTO Control Range			2		3	V
Slope Compensation	V <sub>SCOMP</sub>	MAX5014		26		mV/µs

# Current-Mode PWM Controllers with Integrated Startup Circuit for Isolated Power Supplies

## ELECTRICAL CHARACTERISTICS (continued)

( $V_{DD} = 13V$ , a  $10\mu F$  capacitor connects  $V_{CC}$  to GND,  $V_{CS} = 0$ ,  $V_{+} = 48V$ ,  $0.1\mu F$  capacitor connected to  $\overline{SS\_SHDN}$ , NDRV = open circuit, OPTO = GND,  $T_A = -40^{\circ}C$  to  $+85^{\circ}C$ , unless otherwise noted. Typical values are at  $T_A = +25^{\circ}C$ .)

PARAMETER	SYMBOL	CONDITIONS	MIN	TYP	MAX	UNITS
<b>THERMAL SHUTDOWN</b>						
Thermal Shutdown Temperature				150		$^{\circ}C$
Thermal Hysteresis				25		$^{\circ}C$
<b>CURRENT LIMIT</b>						
CS Threshold Voltage	$V_{LIM}$	$V_{OPTO} = 4V$	419	465	510	mV
CS Input Bias Current		$0 \leq V_{CS} \leq 2V$ , $V_{OPTO} = 4V$	-1		1	$\mu A$
Current Limit Comparator Propagation Delay		25mV overdrive on CS, $V_{OPTO} = 4V$		180		ns
CS Blanking Time		$V_{OPTO} = 4V$		70		ns
<b>OSCILLATOR</b>						
Clock Frequency Range		$V_{OPTO} = 4V$	247	275	302	kHz
Max Duty Cycle		MAX5014, $V_{OPTO} = 4V$	75		85	%
		MAX5015, $V_{OPTO} = 4V$	44		50	
<b>SOFT-START</b>						
SS Source Current	$I_{SSO}$	$V_{SS\_SHDN} = 0$	2.0	4.6	6.5	$\mu A$
SS Sink Current			1.0			mA
Peak Soft-Start Voltage Clamp		No external load	2.331	2.420	2.500	V
Shutdown Threshold		$V_{SS\_SHDN}$ falling	0.25	0.37	0.41	V
		$V_{SS\_SHDN}$ rising	0.53	0.59	0.65	

## Typical Operating Characteristics

( $V_{+} = 48V$ ,  $V_{DD} = 13V$ , NRDV is open circuit,  $T_A = +25^{\circ}C$ , unless otherwise noted.)

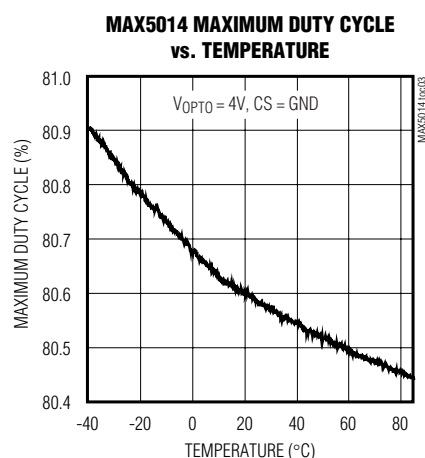
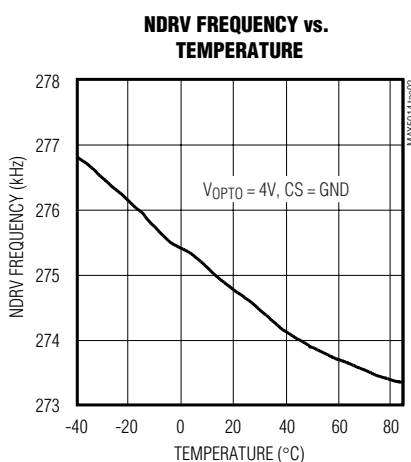
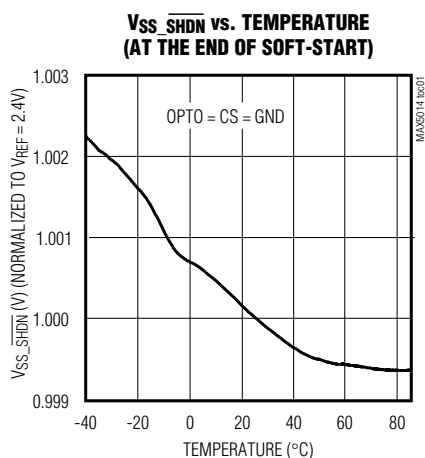

# Current-Mode PWM Controllers with Integrated Startup Circuit for Isolated Power Supplies

## Typical Operating Characteristics (continued)

( $V_+ = 48V$ ,  $V_{DD} = 13V$ , NRDV is open circuit,  $T_A = +25^\circ C$ , unless otherwise noted.)

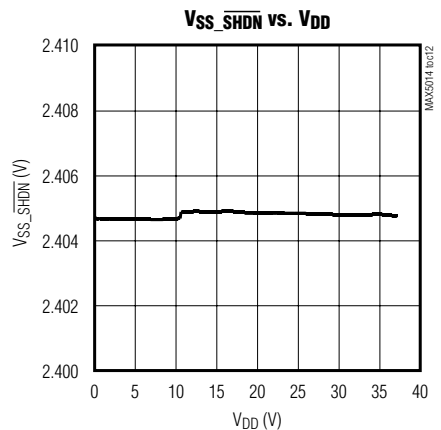
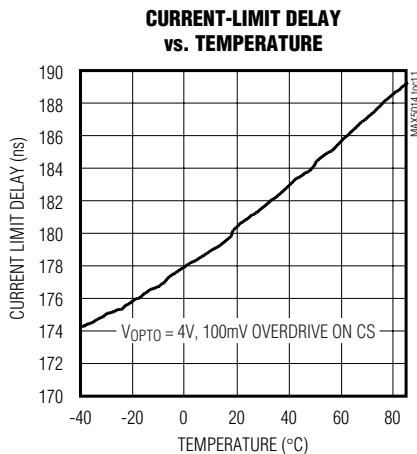
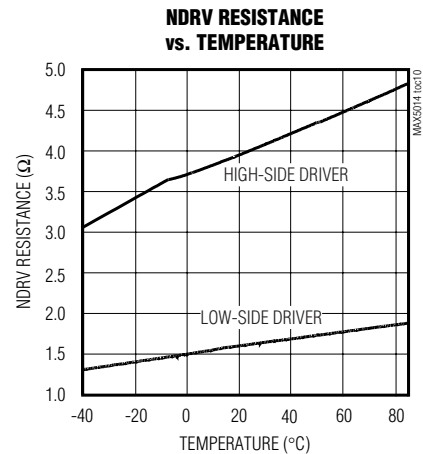
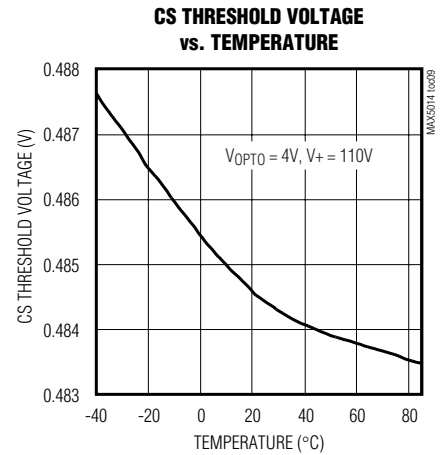
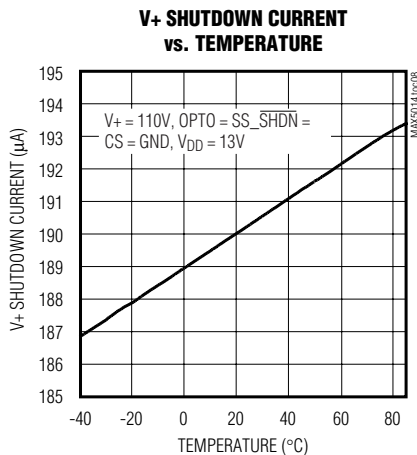
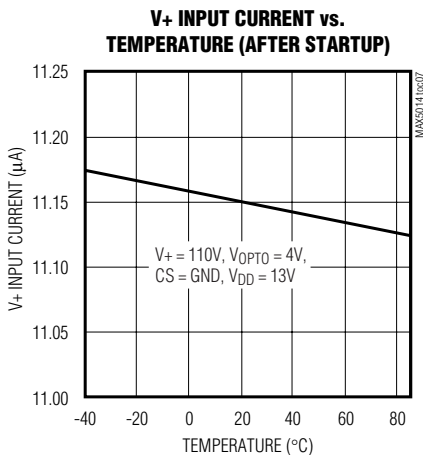
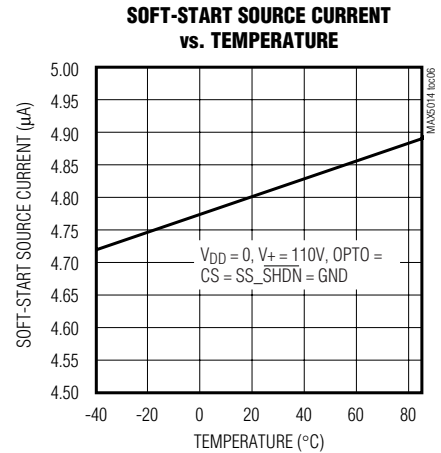
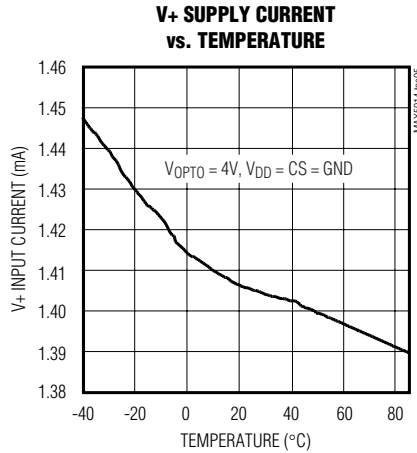
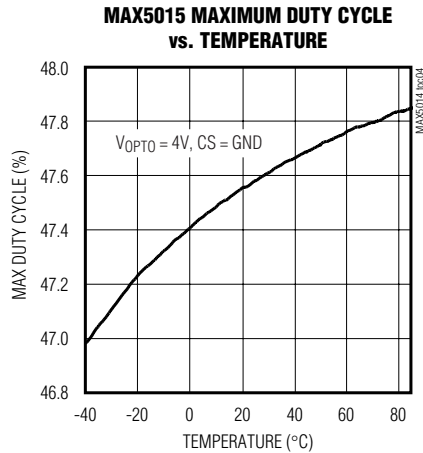

# Current-Mode PWM Controllers with Integrated Startup Circuit for Isolated Power Supplies

## Typical Operating Characteristics (continued)

( $V_+ = 48V$ ,  $V_{DD} = 13V$ , NRDV is open circuit,  $T_A = +25^\circ C$ , unless otherwise noted.)

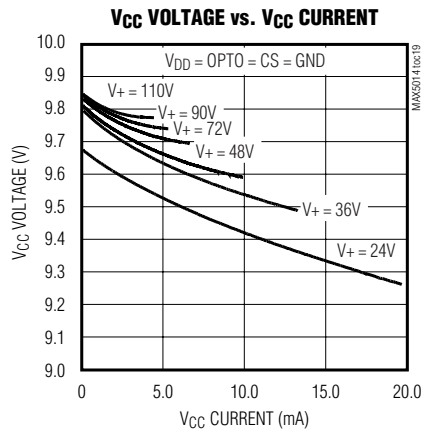
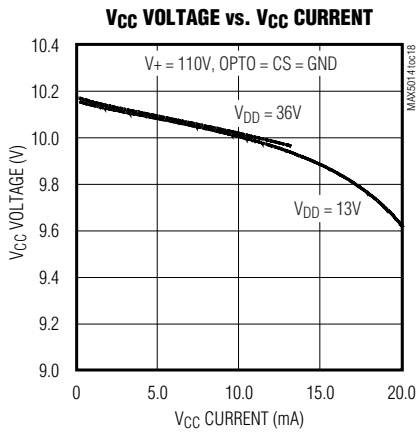
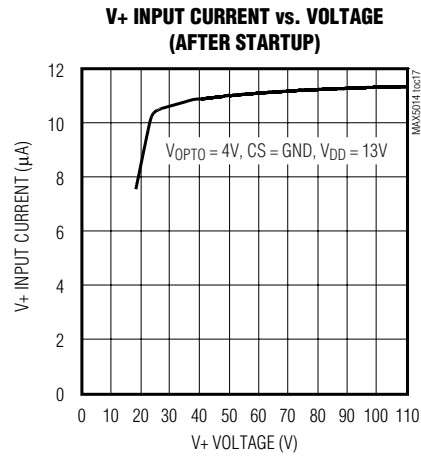
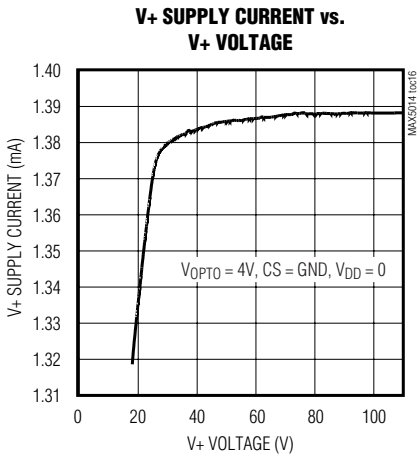
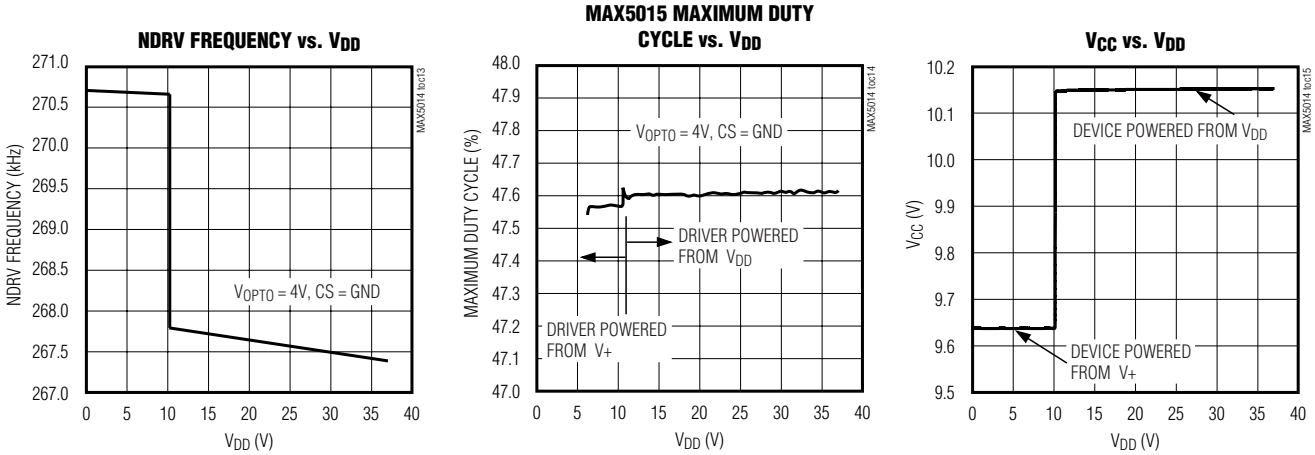

# Current-Mode PWM Controllers with Integrated Startup Circuit for Isolated Power Supplies

## Pin Description

PIN	NAME	FUNCTION
1	V+	High-Voltage Startup Input. Connect directly to an input voltage between 18V to 110V. Connects internally to a high-voltage linear regulator that generates V <sub>CC</sub> during startup.
2	V <sub>DD</sub>	V <sub>DD</sub> is the Input of the Linear Regulator that Generates V <sub>CC</sub> . For supply voltages less than 36V, V <sub>DD</sub> and V+ can both be connected to the supply. For supply voltages greater than 36V, V <sub>DD</sub> receives its power from the tertiary winding of the transformer and accepts voltages from 13V to 36V. Bypass to GND with a 4.7μF capacitor.
3	OPTO	Optocoupler Input. The control voltage range on this input is 2V to 3V.
4	SS_ŠHDN	Soft-Start Timing Capacitor Connection. Ramp time to full current limit is approximately 0.45ms/nF. This pin is also the reference voltage output. Bypass with a minimum 10nF capacitor to GND. The device goes into shutdown when V <sub>SS_ŠHDN</sub> is pulled below 0.25V.
5	CS	Current Sense Input. Turns power switch off if V <sub>CS</sub> rises above 465mV for cycle-by-cycle current limiting. CS is also the feedback for the current-mode controller. CS is connected to the PWM comparator through a leading edge blanking circuit.
6	GND	Ground
7	NDRV	Gate Drive. Drives a high-voltage external N-channel power MOSFET.
8	V <sub>CC</sub>	Regulated IC Supply. Provides power for the entire IC. V <sub>CC</sub> is regulated from V <sub>DD</sub> during normal operation and from V+ during startup. Bypass V <sub>CC</sub> with a 10μF tantalum capacitor in parallel with 0.1μF ceramic capacitor to GND.

## Detailed Description

Use the MAX5014/MAX5015 PWM current-mode controllers to design flyback- or forward-mode power supplies. Current-mode operation simplifies control-loop design while enhancing loop stability. An internal high-voltage startup regulator allows the device to connect directly to the input supply without an external startup resistor. Current from the internal regulator starts the controller. Once the tertiary winding voltage is established the internal regulator is switched off and bias current for running the IC is derived from the tertiary winding. The internal oscillator is set to 275kHz and trimmed to ±10%. This permits the use of small magnetic components to minimize board space. Both the MAX5014 and MAX5015 can be used in power supplies providing multiple output voltages. A functional diagram of the IC is shown in Figure 1. Typical applications circuits for forward and flyback topologies are shown in Figure 2 and Figure 3, respectively.

### Current-Mode Control

The MAX5014/MAX5015 offer current-mode control operation with added features such as leading-edge blanking with dual internal path that only blanks the sensed current signal applied to the input of the PWM comparator. The current limit comparator monitors the CS pin at all times and provides cycle-by-cycle current

limit without being blanked. The leading-edge blanking of the CS signal prevents the PWM comparator from prematurely terminating the on cycle. The CS signal contains a leading-edge spike that is the result of the MOSFET gate charge current, capacitive and diode reverse recovery current of the power circuit. Since this leading-edge spike is normally lower than the current limit comparator threshold, current limiting is not blanked and cycle-by-cycle current limiting is provided under all conditions.

Use the MAX5014 in discontinuous flyback applications where wide line voltage and load current variation is expected. Use the MAX5015 for single transistor forward converters where the maximum duty cycle must be limited to less than 50%.

Under certain conditions it may be advantageous to use a forward converter with greater than 50% duty cycle. For those cases use the MAX5014. The large duty cycle results in much lower operating primary RMS currents through the MOSFET switch and in most cases a smaller output filter inductor. The major disadvantage to this is that the MOSFET voltage rating must be higher and that slope compensation must be provided to stabilize the inner current loop. The MAX5014 provides internal slope compensation.

# Current-Mode PWM Controllers with Integrated Startup Circuit for Isolated Power Supplies

MAX5014/MAX5015

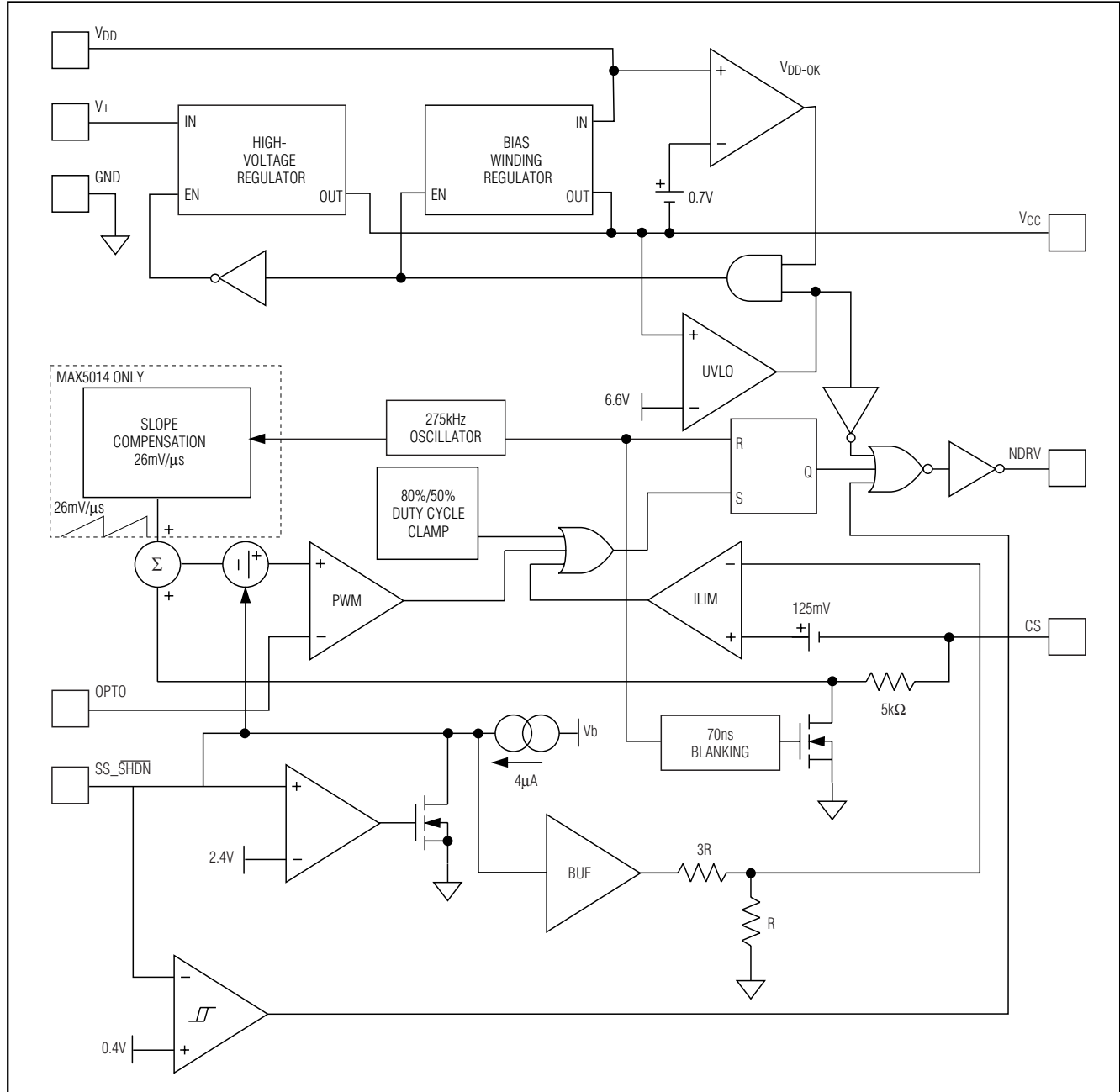

Figure 1. Functional Diagram





# Current-Mode PWM Controllers with Integrated Startup Circuit for Isolated Power Supplies

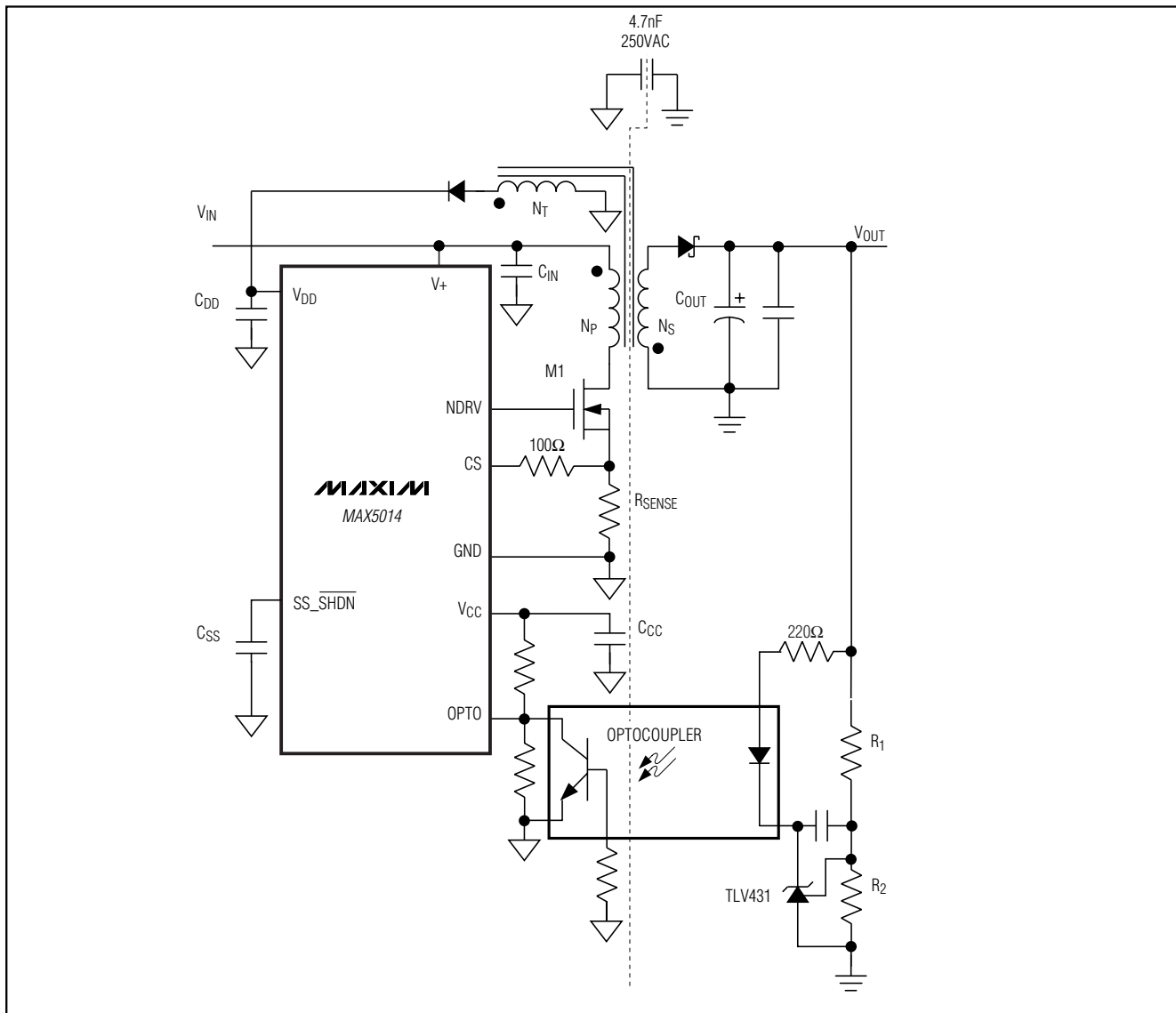

Figure 3. Flyback Converter

To reduce power dissipation the high-voltage regulator is disabled when the  $V_{DD}$  voltage reaches 12.7V. This greatly reduces power dissipation and improves efficiency. If  $V_{CC}$  falls below the undervoltage lockout threshold ( $V_{CC} = 6.6V$ ), the low-voltage regulator is disabled, and soft-start is reinitiated. In undervoltage lockout the MOSFET driver output (NDRV) is held low.

If the input voltage range is between 13V and 36V,  $V_+$  and  $V_{DD}$  may be connected to the line voltage provided that the maximum power dissipation is not exceeded. This eliminates the need for a tertiary winding.

## Undervoltage Lockout (UVLO), Soft-Start, and Shutdown

The soft-start feature of the MAX5014/MAX5015 allows the load voltage to ramp up in a controlled manner, thus eliminating output voltage overshoot.

While the part is in UVLO, the capacitor connected to the SS\_SHDN pin is discharged. Upon coming out of UVLO an internal current source starts charging the capacitor to initiate the soft-start cycle. Use the following equation to calculate total soft-start time:

# Current-Mode PWM Controllers with Integrated Startup Circuit for Isolated Power Supplies

$$t_{\text{startup}} = 0.45 \frac{\text{ms}}{\text{nF}} \times C_{\text{SS}}$$

where  $C_{\text{SS}}$  is the soft-start capacitor as shown in Figure 2.

Operation begins when  $V_{\text{SS\_SHDN}}$  ramps above 0.6V. When soft-start has completed,  $V_{\text{SS\_SHDN}}$  is regulated to 2.4V, the internal voltage reference. Pull  $V_{\text{SS\_SHDN}}$  below 0.25V to disable the controller.

Undervoltage lockout shuts down the controller when  $V_{\text{CC}}$  is less than 6.6V. The regulators for  $V_+$  and the reference remain on during shutdown.

## Current-Sense Comparator

The current-sense (CS) comparator and its associated logic limit the peak current through the MOSFET. Current is sensed at CS as a voltage across a sense resistor between the source of the MOSFET and GND. To reduce switching noise, connect CS to the external MOSFET source through a 100Ω resistor or an RC low-pass filter (Figures 2, 3). Select the current-sense resistor,  $R_{\text{SENSE}}$  according to the following equation:

$$R_{\text{SENSE}} = 0.465V / I_{\text{LimPrimary}}$$

where  $I_{\text{LimPrimary}}$  is the maximum peak primary-side current.

When  $V_{\text{CS}} > 465\text{mV}$ , the power MOSFET switches off. The propagation delay from the time the switch current reaches the trip level to the driver turn-off time is 170ns.

## PWM Comparator and Slope Compensation

An internal 275kHz oscillator determines the switching frequency of the controller. At the beginning of each cycle, NDRV switches the N-channel MOSFET on. NDRV switches the external MOSFET off after the maximum duty cycle has been reached, regardless of the feedback.

The MAX5014 uses an internal ramp generator for slope compensation. The internal ramp signal is reset at the beginning of each cycle and slews at 26mV/μs.

The PWM comparator uses the instantaneous current, the error voltage, the internal reference, and the slope compensation (MAX5014 only) to determine when to switch the N-channel MOSFET off. In normal operation the N-channel MOSFET turns off when:

$$I_{\text{PRIMARY}} \times R_{\text{SENSE}} > V_{\text{OPTO}} - V_{\text{REF}} - V_{\text{SCOMP}}$$

where  $I_{\text{PRIMARY}}$  is the current through the N-channel MOSFET,  $V_{\text{REF}}$  is the 2.4V internal reference and

$V_{\text{SCOMP}}$  is a ramp function starting at 0 and slewing at 26mV/μs (MAX5014 only). When using the MAX5014 in a forward-converter configuration the following condition must be met to avoid control-loop subharmonic oscillations:

$$\frac{N_{\text{S}}}{N_{\text{P}}} \times \frac{k \times R_{\text{SENSE}} \times V_{\text{OUT}}}{L} = 26\text{mV}/\mu\text{s}$$

where  $k = 0.75$  to 1, and  $N_{\text{S}}$  and  $N_{\text{P}}$  are the number of turns on the secondary and primary side of the transformer, respectively.  $L$  is the output filter inductor. This makes the output inductor current downslope as referenced across  $R_{\text{SENSE}}$  equal to the slope compensation. The controller responds to transients within one cycle when this condition is met.

## N-Channel MOSFET Gate Driver

NDRV drives an N-channel MOSFET. NDRV sources and sinks large transient currents to charge and discharge the MOSFET gate. To support such switching transients, bypass  $V_{\text{CC}}$  with a ceramic capacitor. The average current as a result of switching the MOSFET is the product of the total gate charge and the operating frequency. It is this current plus the DC quiescent current that determines the total operating current.

## Applications Information

### Design Example

The following is a general procedure for designing a forward converter (Figure 2) using the MAX5015.

- 1) Determine the requirements.
- 2) Set the output voltage.
- 3) Calculate the transformer primary to secondary winding turns ratio.
- 4) Calculate the reset to primary winding turns ratio.
- 5) Calculate the tertiary to primary winding turns ratio.
- 6) Calculate the current-sense resistor value.
- 7) Calculate the output inductor value.
- 8) Select the output capacitor.

The circuit in Figure 2 was designed as follows:

- 1)  $36\text{V} \leq V_{\text{IN}} \leq 72\text{V}$ ,  $V_{\text{OUT}} = 5\text{V}$ ,  $I_{\text{OUT}} = 10\text{A}$ ,  $V_{\text{RIPPLE}} \leq 50\text{mV}$
- 2) To set the output voltage calculate the values of resistors  $R_1$  and  $R_2$  according to the following equation:

## Current-Mode PWM Controllers with Integrated Startup Circuit for Isolated Power Supplies

$$\frac{V_{REF}}{V_{OUT}} = \frac{R_2}{R_1 + R_2}$$

where  $V_{REF}$  is the reference voltage of the shunt regulator, and  $R_1$  and  $R_2$  are the resistors shown in Figures 2 and 3.

- 3) The turns ratio of the transformer is calculated based on the minimum input voltage and the lower limit of the maximum duty cycle for the MAX5015 (44%). To enable the use of MOSFETs with drain-source breakdown voltages of less than 200V use the MAX5015 with the 50% maximum duty cycle. Calculate the turns ratio according to the following equation:

$$\frac{N_S}{N_P} \geq \frac{V_{OUT} + (V_{D1} \times D_{MAX})}{D_{MAX} \times V_{IN\_MIN}}$$

where:

$N_S/N_P$  = Turns ratio ( $N_S$  is the number of secondary turns and  $N_P$  is the number of primary turns).

$V_{OUT}$  = Output voltage (5V).

$V_{D1}$  = Voltage drop across D1 (typically 0.5V for power Schottky diodes).

$D_{MAX}$  = Minimum value of maximum operating duty cycle (44%).

$V_{IN\_MIN}$  = Minimum Input voltage (36V).

In this example:

$$\frac{N_S}{N_P} \geq \frac{5V + (0.5V \times 0.44)}{0.44 \times 36V} = 0.330$$

Choose  $N_P$  based on core losses and DC resistance. Use the turns ratio to calculate  $N_S$ , rounding up to the nearest integer. In this example  $N_P = 14$  and  $N_S = 5$ .

For a forward converter choose a transformer with a magnetizing inductance in the neighborhood of 200 $\mu$ H. Energy stored in the magnetizing inductance of a forward converter is not delivered to the load and must be returned back to the input; this is accomplished with the reset winding.

The transformer primary to secondary leakage inductance should be less than 1 $\mu$ H. Note that all leakage energy will be dissipated across the MOSFET. Snubber circuits may be used to direct some or

all of the leakage energy to be dissipated across a resistor.

To calculate the minimum duty cycle ( $D_{MIN}$ ) use the following equation:

$$D_{MIN} = \frac{V_{OUT}}{V_{IN\_MAX} \times \frac{N_S}{N_P} - V_{D1}} = 19.8$$

where  $V_{IN\_MAX}$  is the maximum input voltage (72V).

- 4) The reset winding turns ratio ( $N_R/N_P$ ) needs to be low enough to guarantee that the entire energy in the transformer is returned to  $V_+$  within the off cycle at the maximum duty cycle. Use the following equation to determine the reset winding turns ratio:

$$N_R \leq N_P \times \frac{1 - D_{MAX}'}{D_{MAX}'}$$

where:

$N_R/N_P$  = Reset winding turns ratio.

$D_{MAX}'$  = Maximum value of Maximum Duty Cycle.

$$N_R \leq 14 \times \frac{1 - 0.5}{0.5} = 14$$

Round  $N_R$  to the nearest smallest integer.

The turns ratio of the reset winding ( $N_R/N_P$ ) will determine the peak voltage across the N-channel MOSFET.

Use the following equation to determine the maximum drain-source voltage across the N-channel MOSFET:

$$V_{DSMAX} \geq V_{IN\_MAX} \times \left(1 + \frac{N_P}{N_R}\right)$$

$V_{DSMAX}$  = Maximum MOSFET drain-source voltage.

$V_{IN\_MAX}$  = Maximum input voltage.

$$V_{DSMAX} \geq 72V \times \left(1 + \frac{14}{14}\right) = 144V$$

Choose MOSFETs with appropriate avalanche power ratings to absorb any leakage energy.

- 5) Choose the tertiary winding turns ratio ( $N_T/N_P$ ) so that the minimum input voltage provides the minimum operating voltage at  $V_{DD}$  (13V). Use the follow-

# Current-Mode PWM Controllers with Integrated Startup Circuit for Isolated Power Supplies

ing equation to calculate the tertiary winding turns ratio:

$$\frac{V_{DDMIN} + 0.7}{V_{IN\_MIN}} \times N_p \leq N_T \leq \frac{V_{DDMAX} + 0.7}{V_{IN\_MAX}} \times N_p$$

where:

$V_{DDMIN}$  is the minimum  $V_{DD}$  supply voltage (13V).

$V_{DDMAX}$  is the maximum  $V_{DD}$  supply voltage (36V).

$V_{IN\_MIN}$  is the minimum input voltage (36V).

$V_{IN\_MAX}$  is the maximum input voltage (72V in this design example).

$N_p$  is the number of turns of the primary winding.

$N_T$  is the number of turns of the tertiary winding.

$$\frac{13.7}{36} \times 14 \leq N_T \leq \frac{36.7}{72} \times 14$$

$$5.33 \leq N_T \leq 7.14$$

Choose  $N_T = 6$ .

6) Choose  $R_{SENSE}$  according to the following equation:

$$R_{SENSE} \leq \frac{V_{LIM}}{\frac{N_s}{N_p} \times 1.2 \times I_{OUTMAX}}$$

where:

$V_{LIM}$  is the current-sense comparator trip threshold voltage (0.465V).

$N_s/N_p$  is the secondary side turns ratio (5/14 in this example).

$I_{OUTMAX}$  is the maximum DC output current (10A in this example).

$$R_{SENSE} \leq \frac{0.465V}{\frac{5}{14} \times 1.2 \times 10} = 109m\Omega$$

7) Choose the inductor value so that the peak ripple current (LIR) in the inductor is between 10% and 20% of the maximum output current.

$$L \geq \frac{(V_{OUT} + V_D) \times (1 - D_{MIN})}{2 \times LIR \times 275kHz \times I_{OUTMAX}}$$

where  $V_D$  is the output Schottky diode forward voltage drop (0.5V) and LIR is the ratio of inductor ripple current to DC output current.

$$L \geq \frac{(5.5) \times (1 - 0.198)}{0.4 \times 275kHz \times 10A} = 4.01\mu H$$

8) The size and ESR of the output filter capacitor determine the output ripple. Choose a capacitor with a low ESR to yield the required ripple voltage.

Use the following equations to calculate the peak-to-peak output ripple:

$$V_{RIPPLE} = \sqrt{V_{RIPPLE,ESR}^2 + V_{RIPPLE,C}^2}$$

where:

$V_{RIPPLE}$  is the combined RMS output ripple due to  $V_{RIPPLE,ESR}$ , the ESR ripple, and  $V_{RIPPLE,C}$ , the capacitive ripple. Calculate the ESR ripple and capacitive ripple as follows:

$$V_{RIPPLE,ESR} = I_{RIPPLE} \times ESR$$

$$V_{RIPPLE,C} = I_{RIPPLE} / (2 \times \pi \times 275kHz \times C_{OUT})$$

## Layout Recommendations

All connections carrying pulsed currents must be very short, be as wide as possible, and have a ground plane as a return path. The inductance of these connections must be kept to a minimum due to the high di/dt of the currents in high-frequency switching power converters.

Current loops must be analyzed in any layout proposed, and the internal area kept to a minimum to reduce radiated EMI. Ground planes must be kept as intact as possible.

## Chip Information

TRANSISTOR COUNT: 589

PROCESS: BiCMOS

# Current-Mode PWM Controllers with Integrated Startup Circuit for Isolated Power Supplies

**Table 1. Component Manufacturers**

<b>Power FETS</b>	International Rectifier	<a href="http://www.irf.com">www.irf.com</a>
	Fairchild	<a href="http://www.fairchildsemi.com">www.fairchildsemi.com</a>
	Vishay-Siliconix	<a href="http://www.vishay.com/brands/siliconix/main.html">www.vishay.com/brands/siliconix/main.html</a>
<b>Current-Sense Resistors</b>	Dale-Vishay	<a href="http://www.vishay.com/brands/dale/main.html">www.vishay.com/brands/dale/main.html</a>
	IRC	<a href="http://www.irctt.com/pages/index.cfm">www.irctt.com/pages/index.cfm</a>
<b>Diodes</b>	On Semi	<a href="http://www.onsemi.com">www.onsemi.com</a>
	General Semiconductor	<a href="http://www.gensemi.com">www.gensemi.com</a>
	Central Semiconductor	<a href="http://www.centrasemi.com">www.centrasemi.com</a>
<b>Capacitors</b>	Sanyo	<a href="http://www.sanyo.com">www.sanyo.com</a>
	Taiyo Yuden	<a href="http://www.t-yuden.com">www.t-yuden.com</a>
	AVX	<a href="http://www.avxcorp.com">www.avxcorp.com</a>
<b>Magnetics</b>	Coiltronics	<a href="http://www.cooperet.com">www.cooperet.com</a>
	Coilcraft	<a href="http://www.coilcraft.com">www.coilcraft.com</a>
	Pulse Engineering	<a href="http://www.pulseeng.com">www.pulseeng.com</a>

## Selector Guide

<b>PART</b>	<b>MAXIMUM DUTY CYCLE</b>	<b>SLOPE COMPENSATION</b>
MAX5014CSA	85%	Yes
MAX5014ESA	85%	Yes
MAX5015CSA	50%	No
MAX5015ESA	50%	No

# Current-Mode PWM Controllers with Integrated Startup Circuit for Isolated Power Supplies

## Package Information

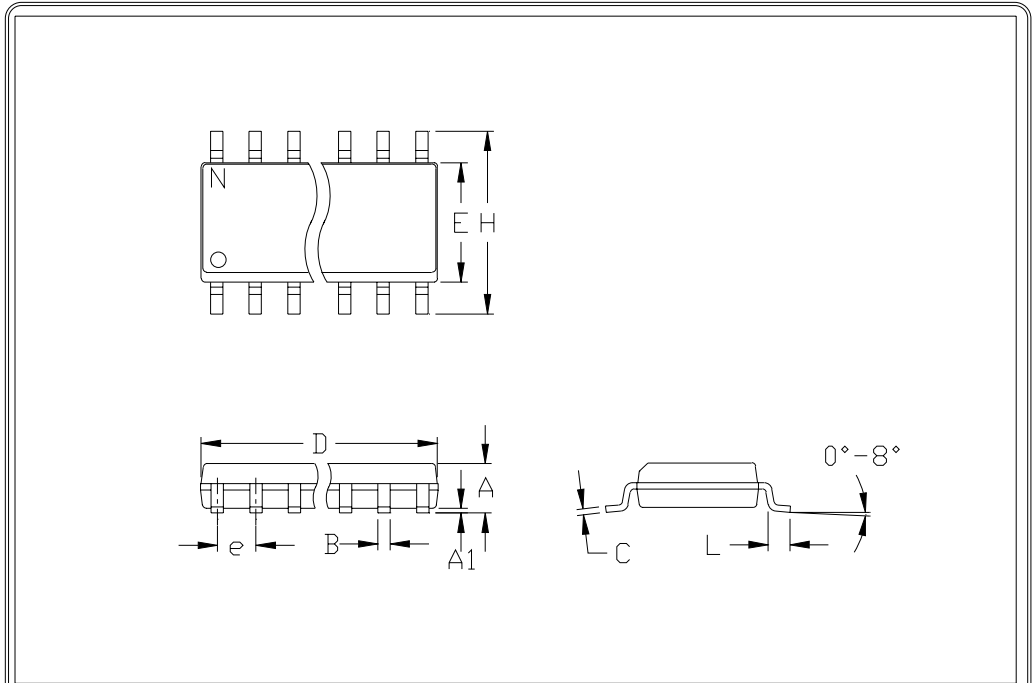

	INCHES		MILLIMETERS	
	MIN	MAX	MIN	MAX
A	0.053	0.069	1.35	1.75
A1	0.004	0.010	0.10	0.25
B	0.014	0.019	0.35	0.49
C	0.007	0.010	0.19	0.25
e	0.050		1.27	
E	0.150	0.157	3.80	4.00
H	0.228	0.244	5.80	6.20
h	0.010	0.020	0.25	0.50
L	0.016	0.050	0.40	1.27

	INCHES		MILLIMETERS		N	MS012
	MIN	MAX	MIN	MAX		
D	0.189	0.197	4.80	5.00	8	A
D	0.337	0.344	8.55	8.75	14	B
D	0.386	0.394	9.80	10.00	16	C

- NOTES:
1. D&E DO NOT INCLUDE MOLD FLASH
  2. MOLD FLASH OR PROTRUSIONS NOT TO EXCEED .15mm (.006")
  3. LEADS TO BE COPLANAR WITHIN .102mm (.004")
  4. CONTROLLING DIMENSION: MILLIMETER
  5. MEETS JEDEC MS012-XX AS SHOWN IN ABOVE TABLE
  6. N = NUMBER OF PINS



PACKAGE FAMILY OUTLINE: SOIC .150"



21-0041 A  
 DOCUMENT CONTROL NUMBER REV

Maxim cannot assume responsibility for use of any circuitry other than circuitry entirely embodied in a Maxim product. No circuit patent licenses are implied. Maxim reserves the right to change the circuitry and specifications without notice at any time.

14 Maxim Integrated Products, 120 San Gabriel Drive, Sunnyvale, CA 94086 408-737-7600

# Mouser Electronics

Authorized Distributor

Click to View Pricing, Inventory, Delivery & Lifecycle Information:

## Maxim Integrated:

[MAX5014CSA+](#) [MAX5014CSA+T](#) [MAX5014ESA+](#) [MAX5014ESA+T](#) [MAX5015CSA+](#) [MAX5015CSA+T](#)  
[MAX5015ESA+](#) [MAX5015ESA+T](#) [MAX5014CSA](#) [MAX5014CSA-T](#) [MAX5014ESA](#) [MAX5014ESA-T](#) [MAX5015CSA](#)  
[MAX5015CSA-T](#) [MAX5015ESA](#) [MAX5015ESA-T](#) [MAX5015ESA-G077](#) [MAX5015ESA-TG077](#)