

INSULATED GATE BIPOLAR TRANSISTOR WITH ULTRAFAST SOFT RECOVERY DIODE

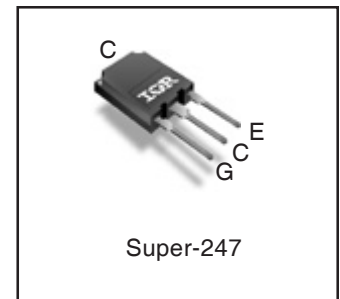
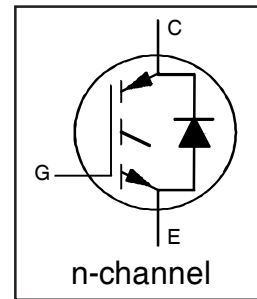

G	C	E
Gate	Collector	Emitter

$V_{CES} = 600V$
$I_C = 160A, T_C = 100^\circ C$
$t_{SC} \geq 5\mu s, T_{J(max)} = 175^\circ C$
$V_{CE(on)} \text{ typ.} = 1.70V @ I_C = 120A$

Applications

- Industrial Motor Drive
- Inverters
- UPS
- Welding

Features	Benefits
Low $V_{CE(ON)}$ and Switching Losses	High efficiency in a wide range of applications and switching frequencies
Square RBSOA and Maximum Junction Temperature 175°C	Improved reliability due to rugged hard switching performance and higher power capability
Positive $V_{CE(ON)}$ Temperature Coefficient	Excellent current sharing in parallel operation
5μs short circuit SOA	Enables short circuit protection scheme
Lead-Free, RoHS compliant	Environmentally friendly

Base part number	Package Type	Standard Pack		Orderable part number
		Form	Quantity	
IRGPS46160DPbF	Super-247	Tube	25	IRGPS46160DPbF

Absolute Maximum Ratings

Parameter	Max.	Units
V_{CES} Collector-to-Emitter Voltage	600	V
$I_C @ T_C = 25^\circ C$ Continuous Collector Current	240 ^②	A
$I_C @ T_C = 100^\circ C$ Continuous Collector Current	160	
I_{CM} Pulse Collector Current, $V_{GE} = 15V$	360	
I_{LM} Clamped Inductive Load Current, $V_{GE} = 20V$ ①	480	
$I_F @ T_C = 25^\circ C$ Diode Continuous Forward Current	240 ^②	
$I_F @ T_C = 100^\circ C$ Diode Continuous Forward Current	160 ^②	V
I_{FM} Diode Maximum Forward Current ④	480	
V_{GE} Continuous Gate-to-Emitter Voltage	±20	V
V_{GE} Transient Gate-to-Emitter Voltage	±30	
$P_D @ T_C = 25^\circ C$ Maximum Power Dissipation	750	W
$P_D @ T_C = 100^\circ C$ Maximum Power Dissipation	375	
T_J Operating Junction and Storage Temperature Range	-55 to +175	°C
T_{STG} Soldering Temperature, for 10 sec.	300 (0.063 in. (1.6mm) from case)	
T_{STG} Mounting Torque, 6-32 or M3 Screw	10 lbf·in (1.1 N·m)	

Thermal Resistance

Parameter	Min.	Typ.	Max.	Units
$R_{\theta JC}$ (IGBT) Junction-to-Case (IGBT) ②	—	—	0.20	°C/W
$R_{\theta JC}$ (Diode) Junction-to-Case (Diode) ②	—	—	0.63	
$R_{\theta CS}$ Case-to-Sink (flat, greased surface)	—	0.24	—	
$R_{\theta JA}$ Junction-to-Ambient (typical socket mount)	—	—	40	

Electrical Characteristics @ T_J = 25°C (unless otherwise specified)

	Parameter	Min.	Typ.	Max.	Units	Conditions
V _{(BR)CES}	Collector-to-Emitter Breakdown Voltage	600	—	—	V	V _{GE} = 0V, I _C = 100μA ③
ΔV _{(BR)CES} /ΔT _J	Temperature Coeff. of Breakdown Voltage	—	0.27	—	V/°C	V _{GE} = 0V, I _C = 4.0mA (25°C-175°C)
V _{CE(on)}	Collector-to-Emitter Saturation Voltage	—	1.70	2.05	V	I _C = 120A, V _{GE} = 15V, T _J = 25°C
		—	2.15	—		I _C = 120A, V _{GE} = 15V, T _J = 150°C
		—	2.20	—		I _C = 120A, V _{GE} = 15V, T _J = 175°C
V _{GE(th)}	Gate Threshold Voltage	4.0	—	6.5	V	V _{CE} = V _{GE} , I _C = 5.6mA
ΔV _{GE(th)} /ΔT _J	Threshold Voltage temp. coefficient	—	-17	—	mV/°C	V _{CE} = V _{GE} , I _C = 5.6mA (25°C - 175°C)
g _{fe}	Forward Transconductance	—	77	—	S	V _{CE} = 50V, I _C = 120A
I _{CES}	Collector-to-Emitter Leakage Current	—	1.0	150	μA	V _{GE} = 0V, V _{CE} = 600V
		—	2.3	—	mA	V _{GE} = 0V, V _{CE} = 600V, T _J = 175°C
V _{FM}	Diode Forward Voltage Drop	—	2.4	3.0	V	I _F = 120A
		—	1.9	—		I _F = 120A, T _J = 175°C
I _{GES}	Gate-to-Emitter Leakage Current	—	—	±400	nA	V _{GE} = ±20V

Switching Characteristics @ T_J = 25°C (unless otherwise specified)

	Parameter	Min.	Typ.	Max.	Units	Conditions
Q _g	Total Gate Charge	—	240	—	nC	I _C = 120A V _{GE} = 15V V _{CC} = 400V
Q _{ge}	Gate-to-Emitter Charge	—	70	—		
Q _{gc}	Gate-to-Collector Charge	—	90	—		
E _{on}	Turn-On Switching Loss	—	5750	—	μJ	I _C = 120A, V _{CC} = 400V, V _{GE} = 15V R _G = 4.7Ω, L = 66μH, T _J = 25°C
E _{off}	Turn-Off Switching Loss	—	3430	—		
E _{total}	Total Switching Loss	—	9180	—		
t _{d(on)}	Turn-On delay time	—	80	—	ns	Energy losses include tail & diode reverse recovery ⑥
t _r	Rise time	—	70	—		
t _{d(off)}	Turn-Off delay time	—	190	—		
t _f	Fall time	—	40	—		
E _{on}	Turn-On Switching Loss	—	7740	—	μJ	I _C = 120A, V _{CC} = 400V, V _{GE} =15V R _G = 4.7Ω, L = 66μH, T _J = 175°C
E _{off}	Turn-Off Switching Loss	—	4390	—		
E _{total}	Total Switching Loss	—	12130	—		
t _{d(on)}	Turn-On delay time	—	80	—	ns	Energy losses include tail & diode reverse recovery ⑥
t _r	Rise time	—	75	—		
t _{d(off)}	Turn-Off delay time	—	230	—		
t _f	Fall time	—	55	—		
C _{ies}	Input Capacitance	—	7750	—	pF	V _{GE} = 0V V _{CC} = 30V f = 1.0Mhz
C _{oes}	Output Capacitance	—	550	—		
C _{res}	Reverse Transfer Capacitance	—	225	—		
RBSOA	Reverse Bias Safe Operating Area	FULL SQUARE				T _J = 175°C, I _C = 480A V _{CC} = 480V, V _p ≤ 600V R _G = 4.7 Ω, V _{GE} = +20V to 0V
SCSOA	Short Circuit Safe Operating Area	5	—	—	μs	V _{CC} = 400V, V _p ≤ 600V R _G = 4.7 Ω, V _{GE} = +15V to 0V
E _{rec}	Reverse Recovery Energy of the Diode	—	500	—	μJ	T _J = 175°C
t _{rr}	Diode Reverse Recovery Time	—	130	—	ns	V _{CC} = 400V, I _F = 120A
I _{rr}	Peak Reverse Recovery Current	—	36	—	A	V _{GE} = 15V, R _G = 4.7 Ω, L = 100μH

Notes:

- ① V_{CC} = 80% (V_{CES}), V_{GE} = 20V, L = 66μH, R_G = 4.7Ω, tested in production I_{LM} ≤ 400A.
- ② Pulse width limited by max. junction temperature.
- ③ Refer to AN-1086 for guidelines for measuring V_{(BR)CES} safely.
- ④ R_θ is measured at T_J of approximately 90°C.
- ⑤ Values influenced by parasitic L and C in measurement.
- ⑥ Calculated continuous current based on maximum allowable junction temperature. Package IGBT current limit is 195A. Package diode current limit is 120A. Note that current limitations arising from heating of the device leads may occur.

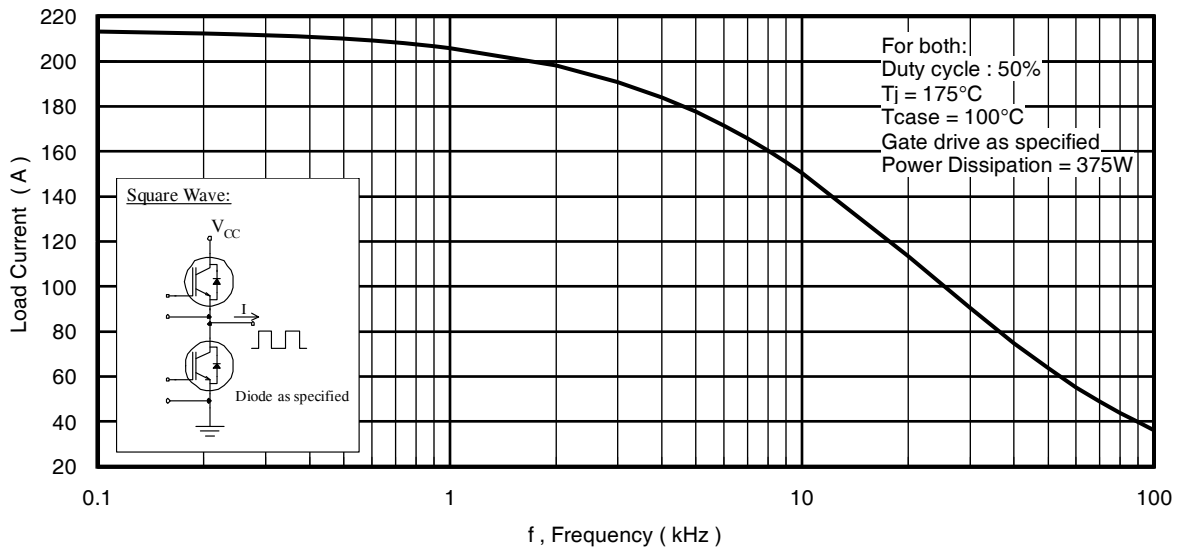

Fig. 1 - Typical Load Current vs. Frequency
(Load Current = I_{RMS} of fundamental)

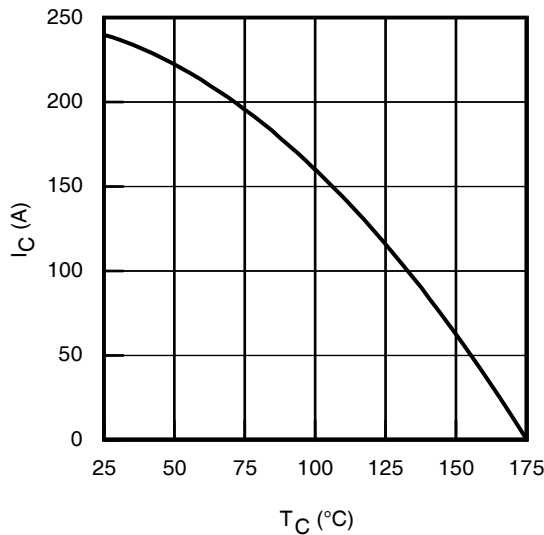

Fig. 2 - Maximum DC Collector Current vs. Case Temperature

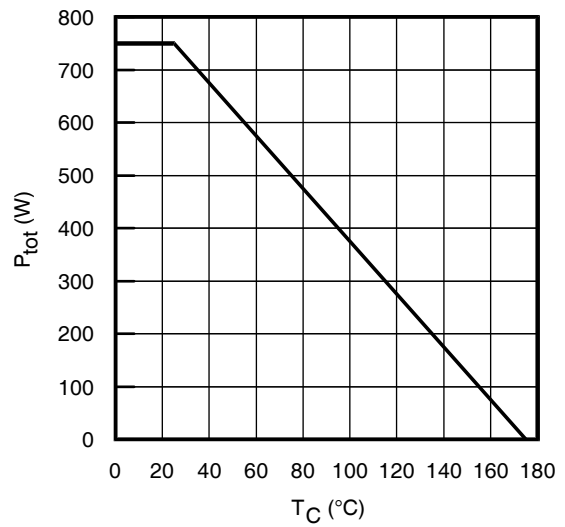

Fig. 3 - Power Dissipation vs. Case Temperature

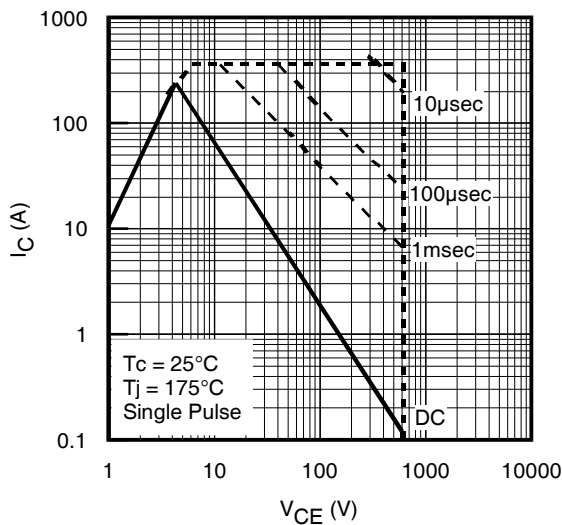

Fig. 4 - Forward SOA
 $T_C = 25^\circ\text{C}$, $T_J \leq 175^\circ\text{C}$; $V_{GE} = 15\text{V}$

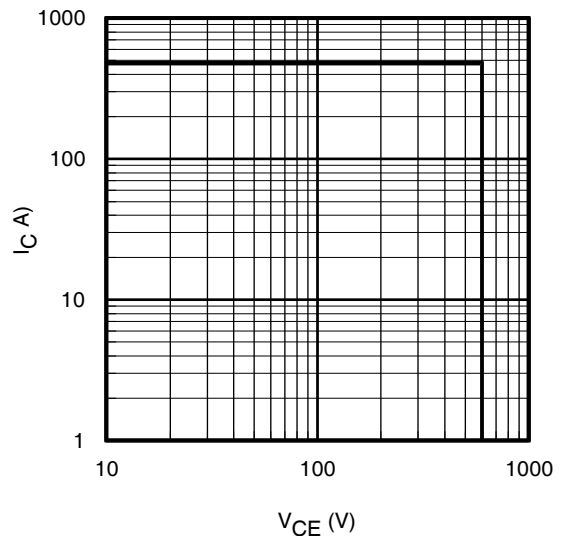

Fig. 5 - Reverse Bias SOA
 $T_J = 175^\circ\text{C}$; $V_{GE} = 20\text{V}$

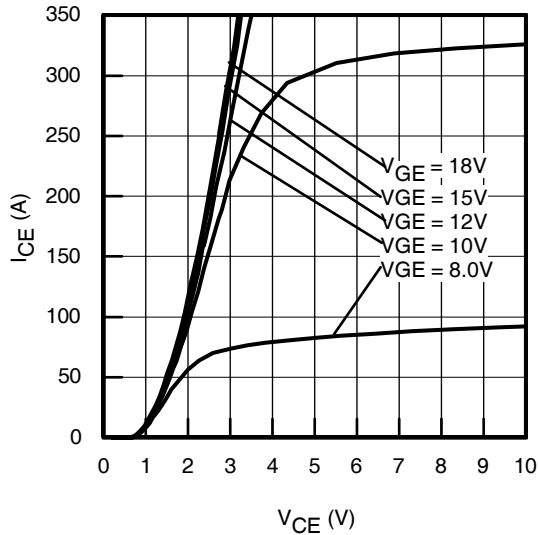

Fig. 6 - Typ. IGBT Output Characteristics
 $T_J = -40^\circ\text{C}$; $t_p = 80\mu\text{s}$

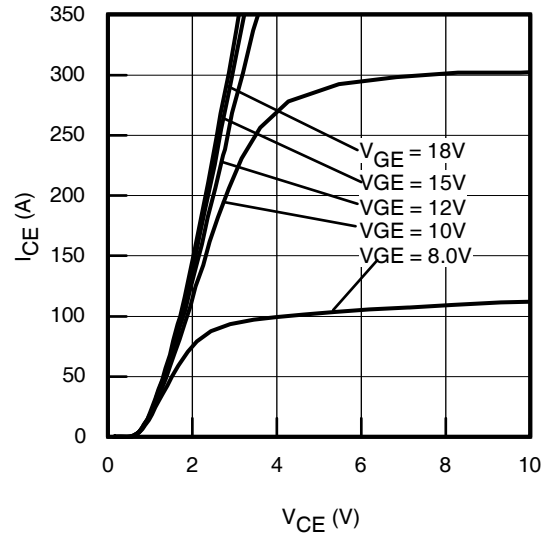

Fig. 7 - Typ. IGBT Output Characteristics
 $T_J = 25^\circ\text{C}$; $t_p = 80\mu\text{s}$

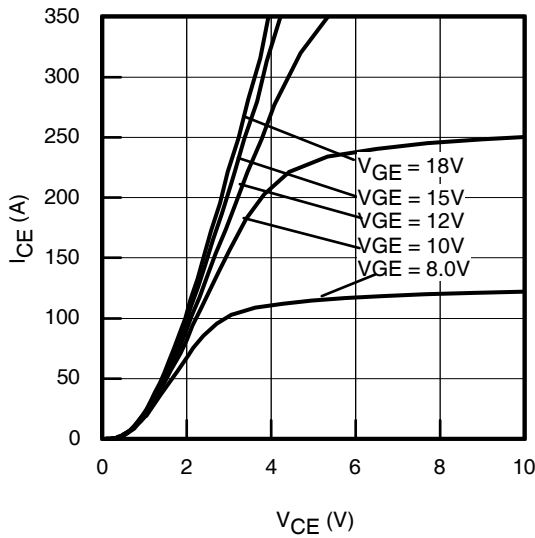

Fig. 8 - Typ. IGBT Output Characteristics
 $T_J = 175^\circ\text{C}$; $t_p = 80\mu\text{s}$

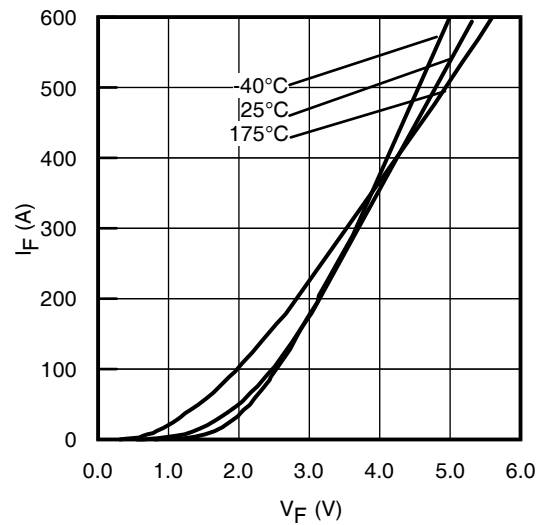

Fig. 9 - Typ. Diode Forward Characteristics
 $t_p = 80\mu\text{s}$

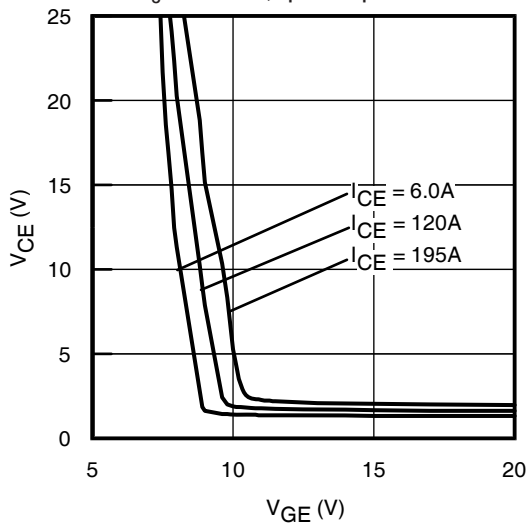

Fig. 10 - Typical V_{CE} vs. V_{GE}
 $T_J = -40^\circ\text{C}$

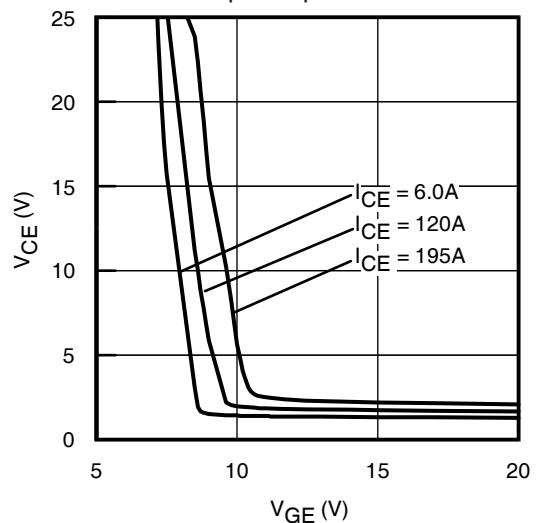

Fig. 11 - Typical V_{CE} vs. V_{GE}
 $T_J = 25^\circ\text{C}$

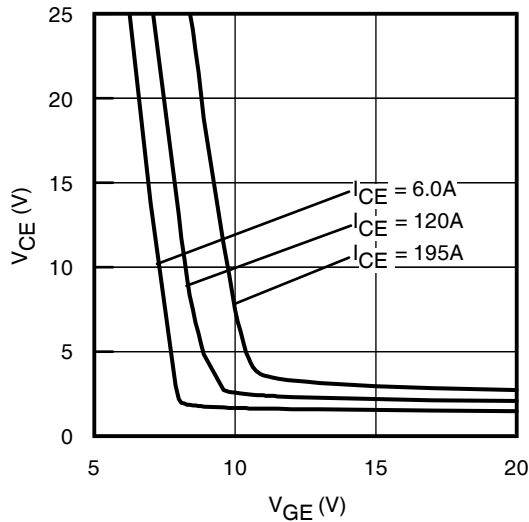

Fig. 12 - Typical V_{CE} vs. V_{GE}
 $T_J = 175^\circ\text{C}$

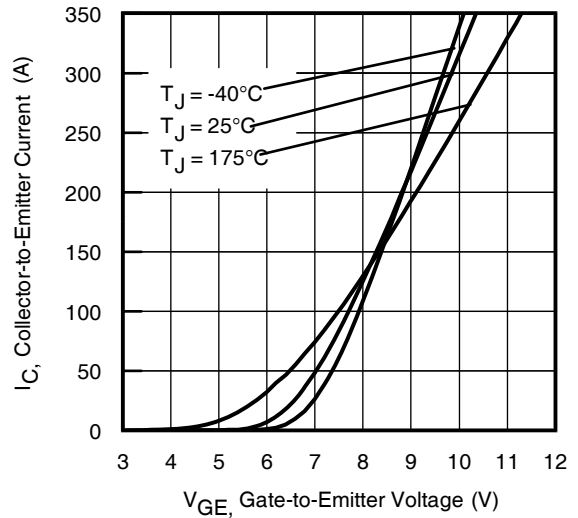

Fig. 13 - Typ. Transfer Characteristics
 $V_{CE} = 50\text{V}$; $t_p = 10\mu\text{s}$

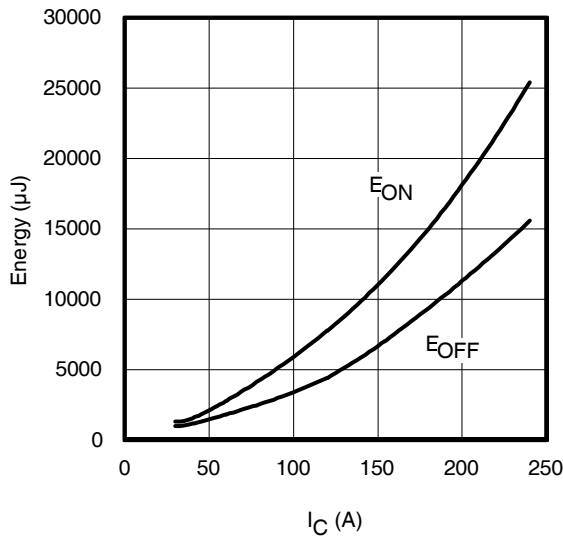

Fig. 14 - Typ. Energy Loss vs. I_C
 $T_J = 175^\circ\text{C}$; $L = 66\mu\text{H}$; $V_{CE} = 400\text{V}$; $R_G = 4.7\Omega$; $V_{GE} = 15\text{V}$

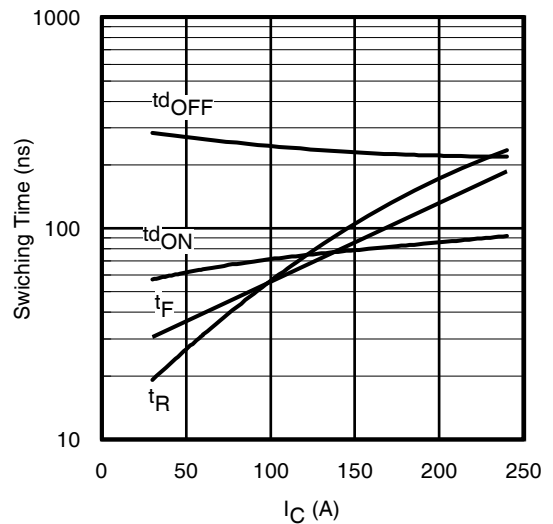

Fig. 15 - Typ. Switching Time vs. I_C
 $T_J = 175^\circ\text{C}$; $L = 66\mu\text{H}$; $V_{CE} = 400\text{V}$; $R_G = 4.7\Omega$; $V_{GE} = 15\text{V}$

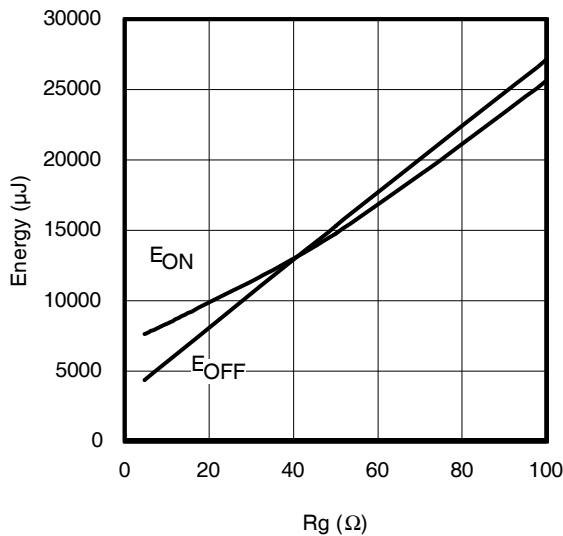

Fig. 16 - Typ. Energy Loss vs. R_G
 $T_J = 175^\circ\text{C}$; $L = 66\mu\text{H}$; $V_{CE} = 400\text{V}$; $I_{CE} = 120\text{A}$; $V_{GE} = 15\text{V}$

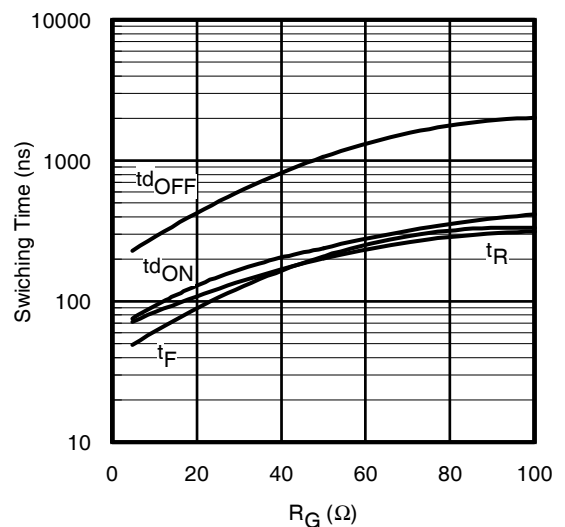

Fig. 17 - Typ. Switching Time vs. R_G
 $T_J = 175^\circ\text{C}$; $L = 66\mu\text{H}$; $V_{CE} = 400\text{V}$; $I_{CE} = 120\text{A}$; $V_{GE} = 15\text{V}$

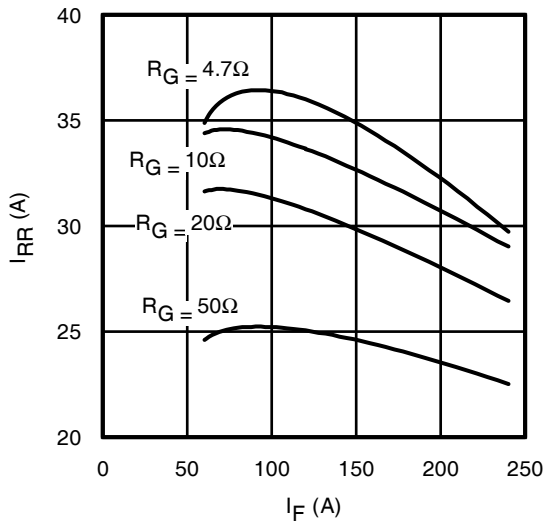

Fig. 18 - Typ. Diode I_{RR} vs. I_F
 $T_J = 175^\circ\text{C}$

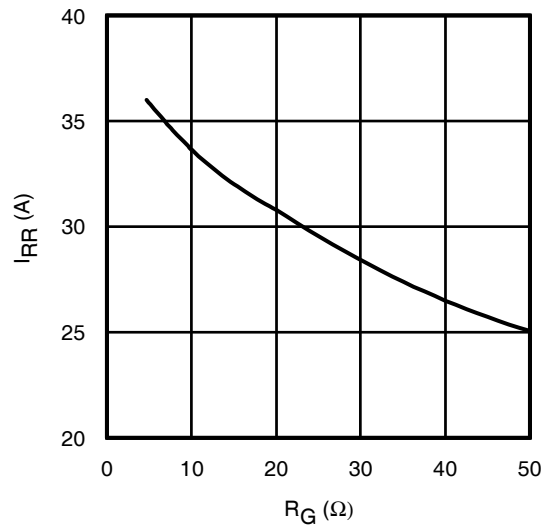

Fig. 19 - Typ. Diode I_{RR} vs. R_G
 $T_J = 175^\circ\text{C}$

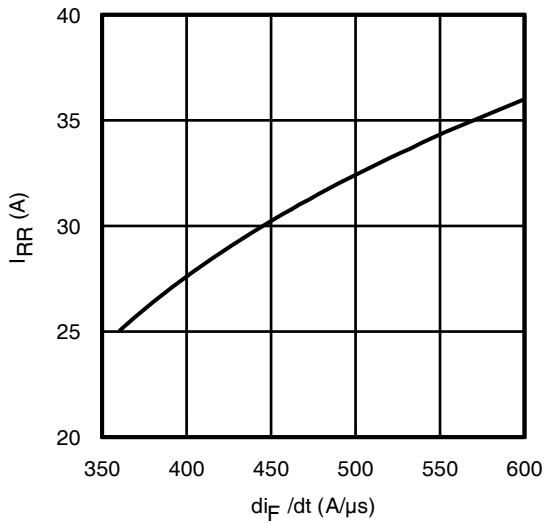

Fig. 20 - Typ. Diode I_{RR} vs. di_F/dt
 $V_{CC} = 400\text{V}$; $V_{GE} = 15\text{V}$; $I_F = 120\text{A}$; $T_J = 175^\circ\text{C}$

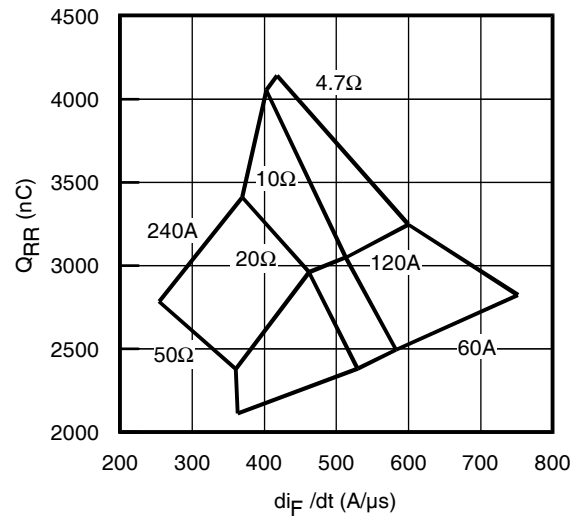

Fig. 21 - Typ. Diode Q_{RR} vs. di_F/dt
 $V_{CC} = 400\text{V}$; $V_{GE} = 15\text{V}$; $T_J = 175^\circ\text{C}$

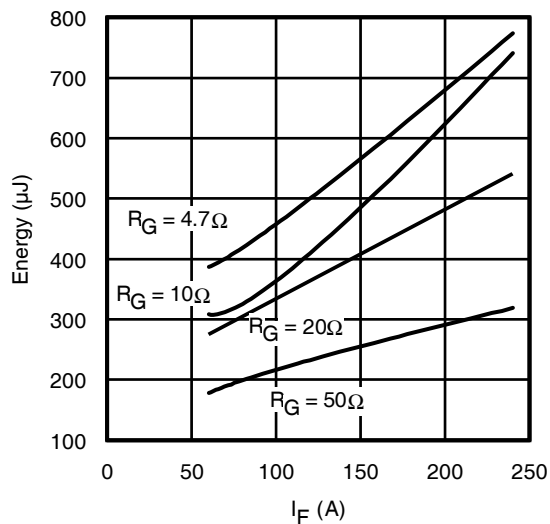

Fig. 22 - Typ. Diode E_{RR} vs. I_F
 $T_J = 175^\circ\text{C}$

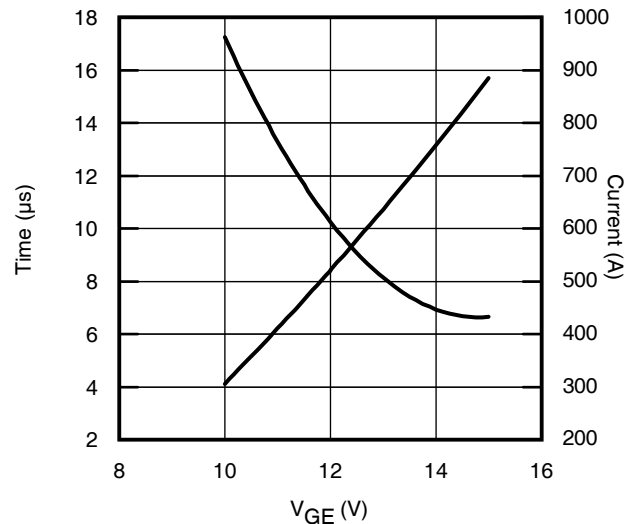

Fig. 23 - V_{GE} vs. Short Circuit Time
 $V_{CC} = 400\text{V}$; $T_C = 25^\circ\text{C}$

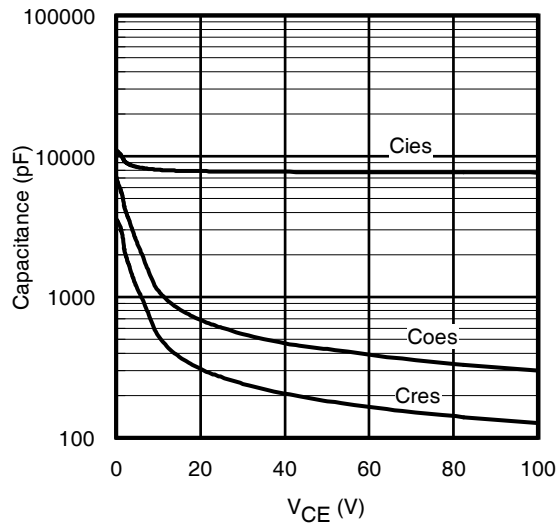

Fig. 24 - Typ. Capacitance vs. V_{CE}
 $V_{GE} = 0V$; $f = 1MHz$

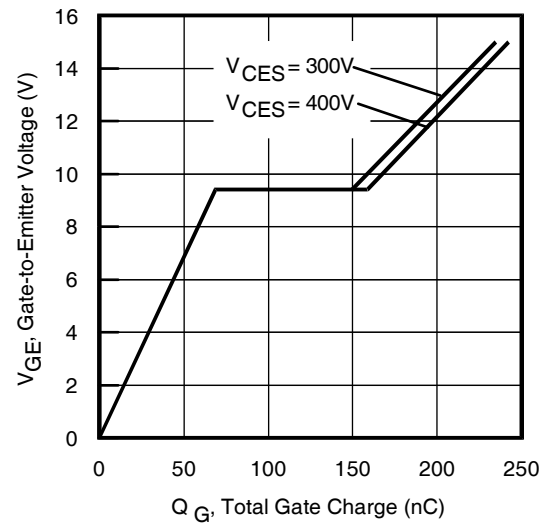

Fig. 25 - Typical Gate Charge vs. V_{GE}
 $I_{CE} = 120A$; $L = 100\mu H$

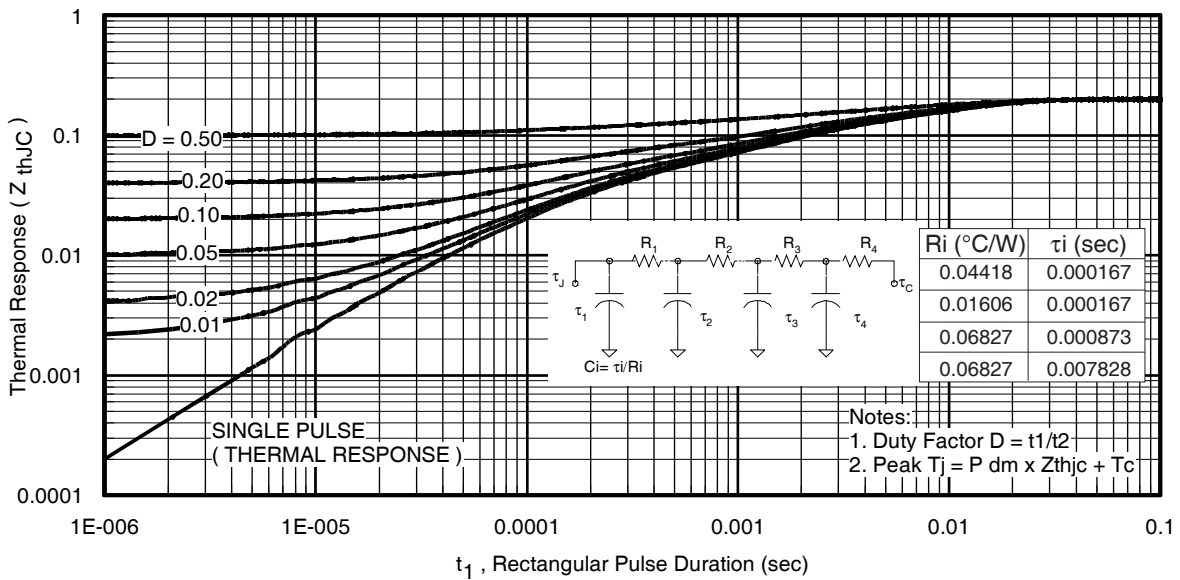

Fig. 26. Maximum Transient Thermal Impedance, Junction-to-Case (IGBT)

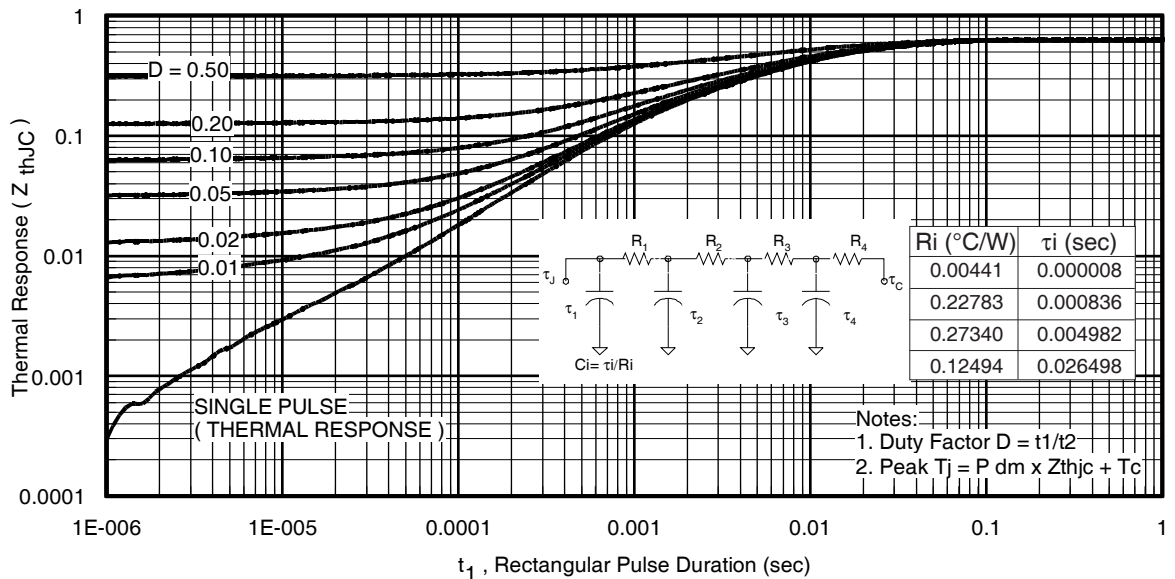
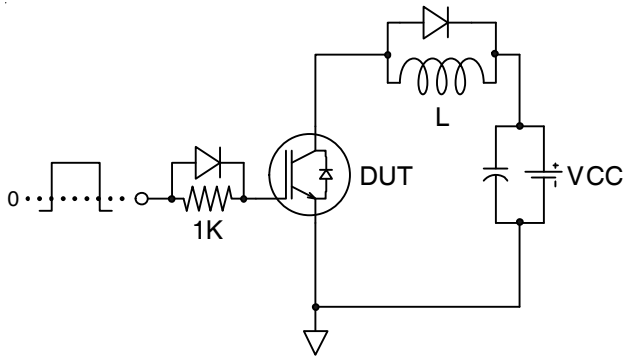
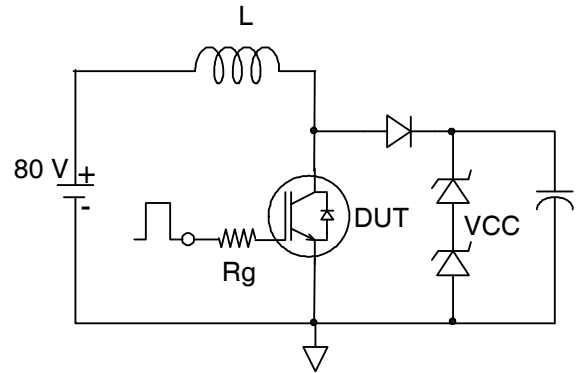
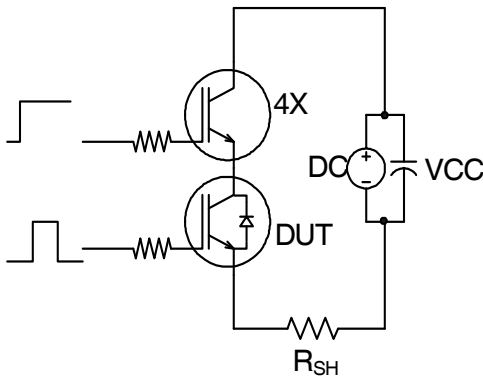
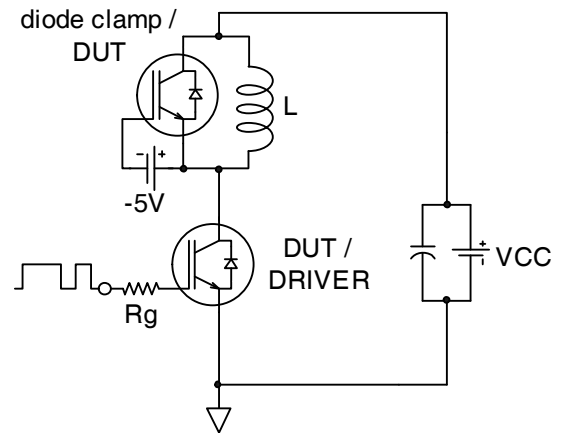
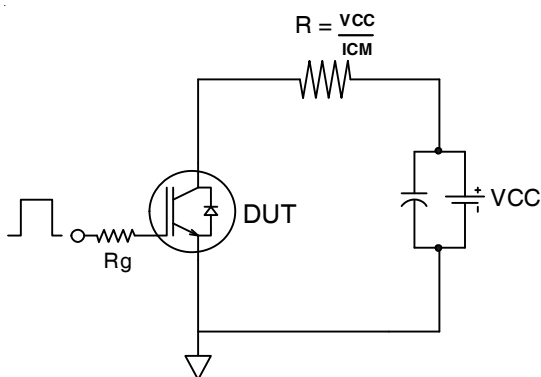
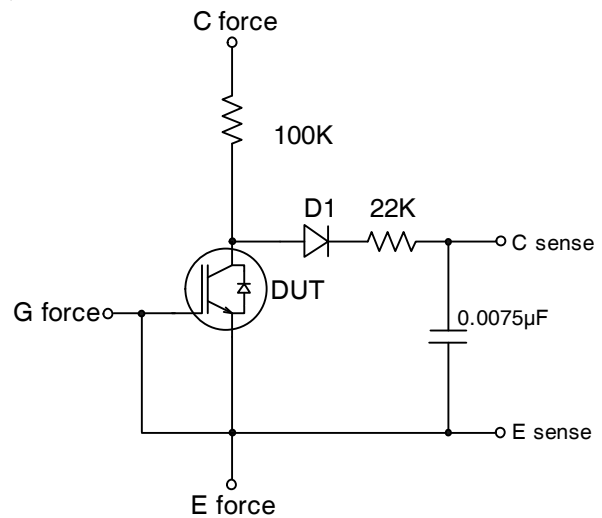

Fig. 27. Maximum Transient Thermal Impedance, Junction-to-Case (DIODE)

Fig.C.T.1 - Gate Charge Circuit (turn-off)

Fig.C.T.2 - RBSOA Circuit

Fig.C.T.3 - S.C. SOA Circuit

Fig.C.T.4 - Switching Loss Circuit

Fig.C.T.5 - Resistive Load Circuit

Fig.C.T.6 - BVCES Filter Circuit

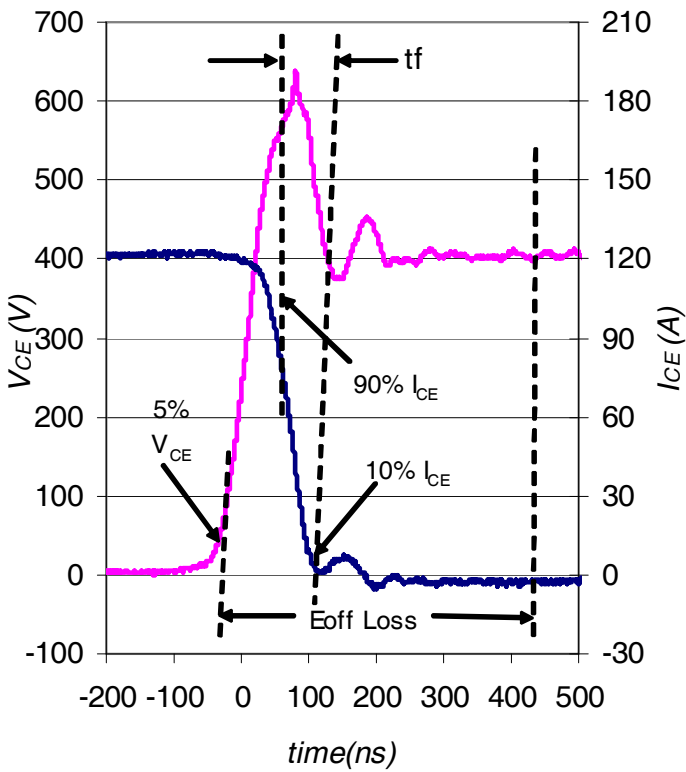

Fig. WF1 - Typ. Turn-off Loss Waveform
@ $T_J = 175^\circ\text{C}$ using Fig. CT.4

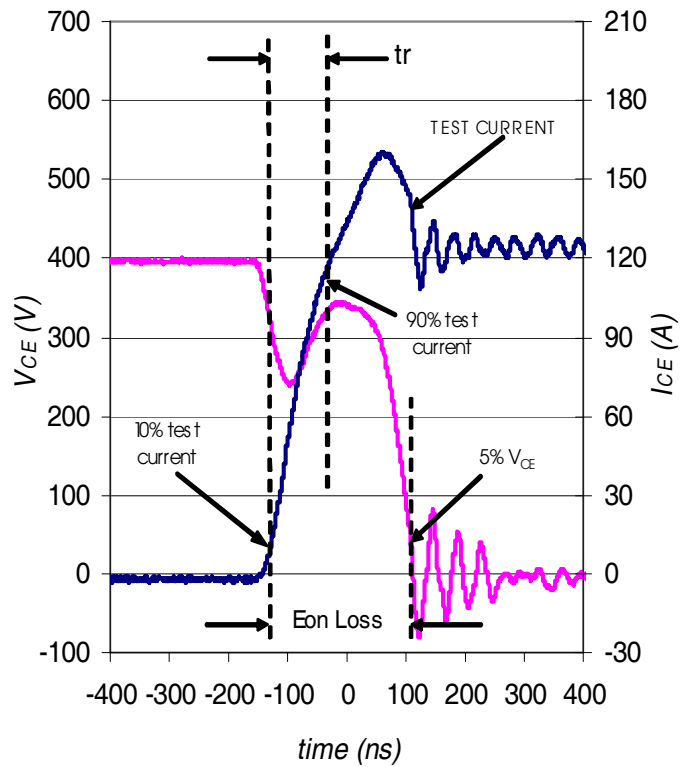

Fig. WF2 - Typ. Turn-on Loss Waveform
@ $T_J = 175^\circ\text{C}$ using Fig. CT.4

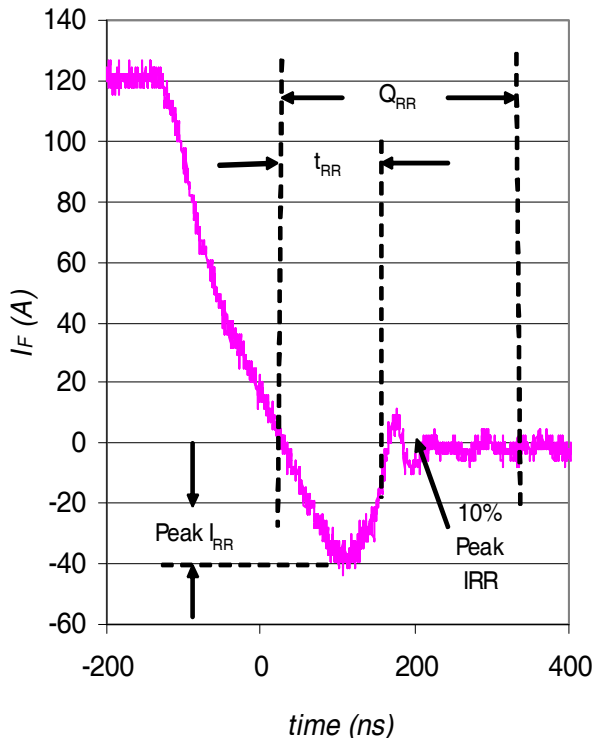

Fig. WF3 - Typ. Diode Recovery Waveform
@ $T_J = 175^\circ\text{C}$ using Fig. CT.4

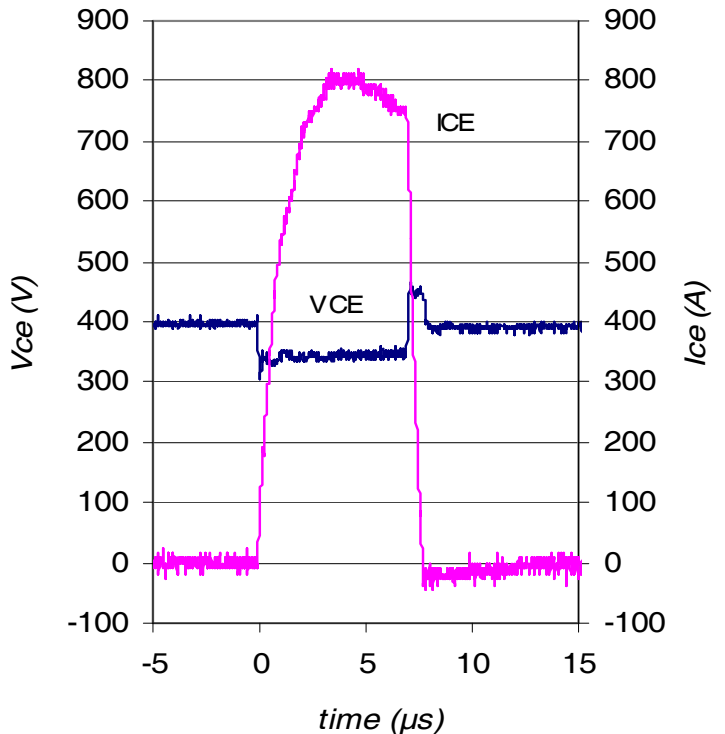
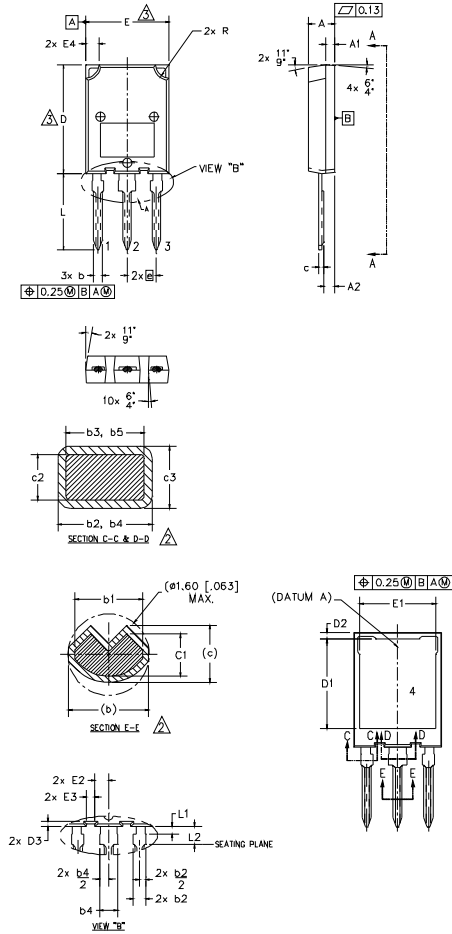

Fig. WF4 - Typ. S.C. Waveform
@ $T_J = 25^\circ\text{C}$ using Fig. CT.3

Case Outline and Dimensions — Super-247



- NOTES:
1. DIMENSIONING AND TOLERANCING AS PER ASME Y14.5M-1994
 2. DIMENSIONS b1, b3, b5, c1 & c3 APPLY TO BASE METAL ONLY.
 3. DIMENSION D & E DO NOT INCLUDE MOLD FLASH. MOLD FLASH SHALL NOT EXCEED 0.127 [0.005"] PER SIDE. THESE DIMENSIONS ARE MEASURED AT THE OUTER EXTREMES OF THE PLASTIC BODY.
 4. ALL DIMENSIONS SHOWN IN MILLIMETERS.
 5. CONTROLLING DIMENSION: MILLIMETER.
 6. OUTLINE CONFORMS TO JEDEC OUTLINE TO-274AA

SYMBOL	DIMENSIONS				NOTES
	MILLIMETERS		INCHES		
	MIN.	MAX.	MIN.	MAX.	
A	4.50	5.50	.177	.217	
A1	1.45	2.15	.057	.085	
A2	1.65	2.35	.065	.093	
b	1.45	1.60	.054	.063	
b1	1.40	1.50	.055	.059	2
b2	2.00	2.40	.079	.094	
b3	1.95	2.35	.077	.093	2
b4	3.00	3.15	.118	.124	
b5	2.95	3.35	.116	.132	2
c	1.10	1.30	.043	.051	
c1	0.90	1.10	.035	.043	2
c2	0.65	0.85	.026	.033	
c3	0.50	0.70	.020	.028	2
D	19.80	20.80	.780	.819	3
D1	15.50	16.10	.610	.634	
D2	0.70	1.30	.028	.051	
D3	0.75	1.25	.030	.049	
E	15.10	16.10	.594	.634	3
E1	13.30	13.90	.524	.547	
E2	2.25	2.70	.089	.109	
E3	1.20	1.70	.047	.067	
E4	2.00	3.00	.079	.118	
e	5.45 BSC		.215 BSC		
L	13.80	14.80	.535	.583	
L1	1.00	1.60	.039	.063	
L2	3.85	4.25	.152	.167	
R	2.00	3.00	.079	.118	

LEAD ASSIGNMENTS

MOSEFT

- 1.- GATE
- 2.- DRAIN
- 3.- SOURCE
- 4.- DRAIN

IGBT

- 1.- GATE
- 2.- COLLECTOR
- 3.- EMITTER
- 4.- COLLECTOR

Super-247 (TO-274AA) Part Marking Information

EXAMPLE: THIS IS AN IRFPS37N50A WITH
ASSEMBLY LOT CODE 1789
ASSEMBLED ON WW 19, 1997
IN THE ASSEMBLY LINE "C"

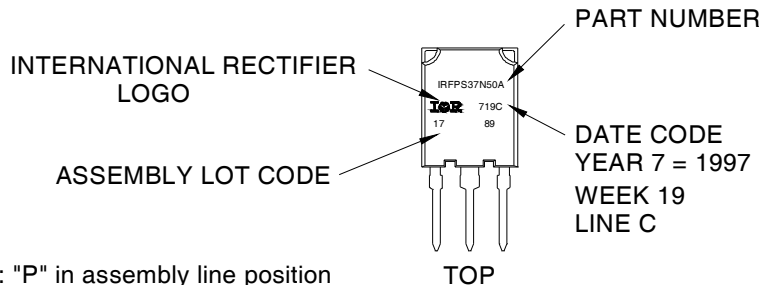

Note: "P" in assembly line position indicates "Lead-Free"

Note: For the most current drawing please refer to IR website at <http://www.irf.com/package/>

Qualification Information[†]

Qualification Level		Industrial (per International Rectifier's internal guidelines)	
Moisture Sensitivity Level		Super-247	N/A
ESD	Human Body Model	Class H3B (8000V) ^{††} AEC-Q101-001	
	Charged Device Model	Class C5 (1125V) ^{††} AEC-Q101-005	
RoHS Compliant		Yes	

† Qualification standards can be found at International Rectifier's web site: <http://www.irf.com/product-info/reliability>

†† Highest passing voltage.

Revision History

Date	Comments
11/14/2014	<ul style="list-style-type: none"> • Added note ④ to I_{FM} Diode Maximum Forward Current on page 1. • Added note ⑤ to switching losses test condition on page 2.