

### DESCRIPTION

The HY628400 is a high-speed, low power and 4M bits CMOS SRAM organized as 524,288 words by 8 bits. The HY628400 uses Hyundai's high performance twin tub CMOS process technology and was designed for high-speed and low power circuit technology. It is particularly well suited for use in high-density and low power system applications. This device has a data retention mode that guarantees data to remain valid at the minimum power supply voltage of 2.0V.

### FEATURES

- Fully static operation and Tri-state outputs
- TTL compatible inputs and outputs
- Low power consumption
- Battery backup(L/LL-part)  
- 2.0V(min) data retention
- Standard pin configuration  
- 32pin 525mil SOP  
- 32pin 400mil TSOP-II  
(Standard and Reversed)

| Product No. | Voltage | Speed    | Operation   | Standby Current(uA) |    | Temperature  |
|-------------|---------|----------|-------------|---------------------|----|--------------|
|             | (V)     | (ns)     | Current(mA) | L                   | LL | (°C)         |
| HY628400    | 5.0     | 55/70/85 | 10          | 100                 | 30 | 0~70(Normal) |

Note 1. Normal : Normal Temperature  
2. Current value are max.

### PIN CONNECTION

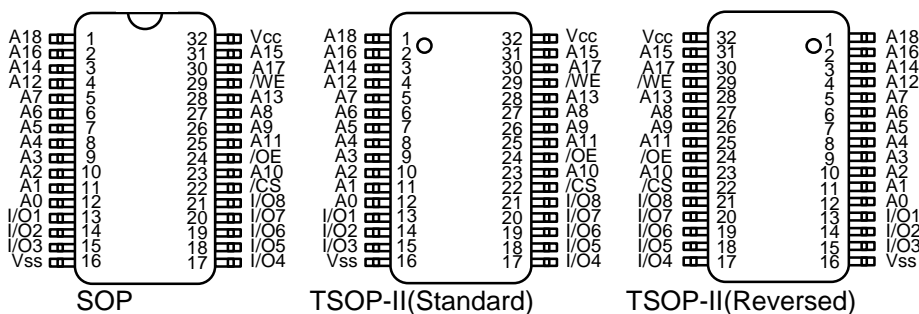

### PIN DESCRIPTION

| Pin Name    | Pin Function      |
|-------------|-------------------|
| /CS         | Chip Select       |
| /WE         | Write Enable      |
| /OE         | Output Enable     |
| A0 ~ A18    | Address Input     |
| I/O1 ~ I/O8 | Data Input/Output |
| Vcc         | Power(5.0V)       |
| Vss         | Ground            |

### BLOCK DIAGRAM

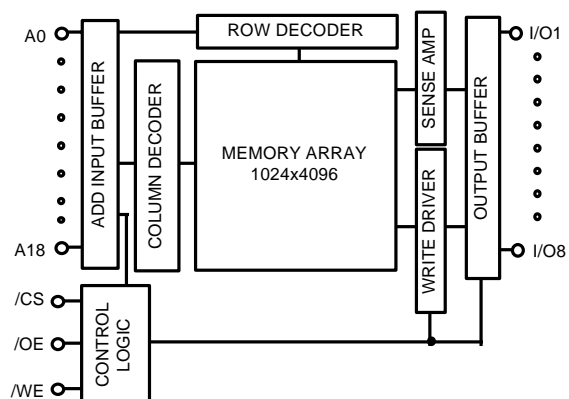

**ORDERING INFORMATION**

| Part No.     | Speed    | Power   | Temp | Package           |
|--------------|----------|---------|------|-------------------|
| HY628400LG   | 55/70/85 | L-part  |      | SOP               |
| HY628400LLG  | 55/70/85 | LL-part |      | SOP               |
| HY628400LT2  | 55/70/85 | L-part  |      | TSOP-II(Standard) |
| HY628400LLT2 | 55/70/85 | LL-part |      | TSOP-II(Standard) |
| HY628400LR2  | 55/70/85 | L-part  |      | TSOP-II(Reversed) |
| HY628400LLR2 | 55/70/85 | LL-part |      | TSOP-II(Reversed) |

**ABSOLUTE MAXIMUM RATING (1)**

| Symbol   | Parameter                          | Rating      | Unit   | Remark   |
|--|------------------------------------|-------------|--------|----------|
| V <sub>CC</sub> , V <sub>IN</sub> , V <sub>OUT</sub> | Power Supply, Input/Output Voltage | -0.5 to 7.0 | V      |          |
| T <sub>A</sub>                                       | Operating Temperature              | 0 to 70     | °C     | HY628400 |
| T <sub>STG</sub>                                     | Storage Temperature                | -65 to 125  | °C     |          |
| P <sub>D</sub>                                       | Power Dissipation                  | 1.0         | W      |          |
| T <sub>SOLDER</sub>                                  | Lead Soldering Temperature & Time  | 260 • 10    | °C•sec |          |

**Note**

- Stresses greater than those listed under ABSOLUTE MAXIMUM RATINGS may cause permanent damage to the device. This is stress rating only and the functional operation of the device under these or any other conditions above those indicated in the operation of this specification is not implied. Exposure to the absolute maximum rating conditions for extended period may affect reliability.

**RECOMMENDED DC OPERATING CONDITION**

 T<sub>A</sub>=0°C to 70°C (Normal)

| Symbol          | Parameter          | Min.    | Typ. | Max.                 | Unit |
|-----------------|--------------------|---------|------|----------------------|------|
| V <sub>CC</sub> | Supply Voltage     | 4.5     | 5.0  | 5.5                  | V    |
| V <sub>SS</sub> | Ground             | 0       | 0    | 0                    | V    |
| V <sub>IH</sub> | Input High Voltage | 2.2     | -    | V <sub>CC</sub> +0.5 | V    |
| V <sub>IL</sub> | Input Low Voltage  | -0.5(1) | -    | 0.8                  | V    |

**Note :**

- V<sub>IL</sub> = -3.0V for pulse width less than 30ns

**TRUTH TABLE**

| /CS1 | /WE | /OE | MODE            | I/O OPERATION |
|------|-----|-----|-----------------|---------------|
| H    | X   | X   | Standby         | High-Z        |
| L    | H   | H   | Output Disabled | High-Z        |
| L    | H   | L   | Read            | Data Out      |
| L    | L   | X   | Write           | Data In       |

**Note :**

- H=V<sub>IH</sub>, L=V<sub>IL</sub>, X=don't care

## DC ELECTRICAL CHARACTERISTICS

V<sub>cc</sub> = 5.0V ±10%, T<sub>A</sub> = 0°C to 70°C (Normal) unless otherwise specified

| Symbol           | Parameter                       |          | Test Condition   | Min | Typ | Max | Unit |    |
|------------------|---------------------------------|----------|--|-----|-----|-----|------|----|
| I <sub>LI</sub>  | Input Leakage Current           |          | V <sub>ss</sub> ≤ V <sub>IN</sub> ≤ V <sub>cc</sub>  | -1  | -   | 1   | μA   |    |
| I <sub>LO</sub>  | Output Leakage Current          |          | V <sub>ss</sub> ≤ V <sub>OUT</sub> ≤ V <sub>cc</sub> , /CS = V <sub>IH</sub> or<br>or /OE = V <sub>IH</sub> or /WE = V <sub>IL</sub> | -1  | -   | 1   | μA   |    |
| I <sub>cc</sub>  | Operating Power Supply Current  |          | /CS = V <sub>IL</sub> ,<br>V <sub>IN</sub> = V <sub>IH</sub> or V <sub>IL</sub> , I <sub>I/O</sub> = 0mA                             | -   | 5   | 10  | mA   |    |
| I <sub>CC1</sub> | Average Operating Current       |          | /CS = V <sub>IL</sub><br>Min Duty Cycle = 100%, I <sub>I/O</sub> = 0mA   | -   | 50  | 80  | mA   |    |
| I <sub>SB</sub>  | TTL Standby Current (TTL Input) |          | /CS = V <sub>IH</sub>  | -   | 0.4 | 2   | mA   |    |
| I <sub>SB1</sub> | Standby Current (CMOS Input)    | HY628400 | /CS ≥ V <sub>cc</sub> - 0.2V   | L   | -   | -   | 100  | μA |
|                  |                                 |          |  | LL  | -   | -   | 30   | μA |
| V <sub>OL</sub>  | Output Low Voltage              |          | I <sub>OL</sub> = 2.1mA  | -   | -   | 0.4 | V    |    |
| V <sub>OH</sub>  | Output High Voltage             |          | I <sub>OH</sub> = -1mA   | 2.4 | -   | -   | V    |    |

Note : Typical values are at V<sub>cc</sub> = 5.0V, T<sub>A</sub> = 25°C

## ERISTICS

V<sub>cc</sub> = 5.0V ± 10%, T<sub>A</sub> = 0°C to 70°C (Normal) unless otherwise specified

| #           | Symbol | Parameter                            | -55  |      | -70  |      | -85 |      | Unit |
|-------------|--------|--------------------------------------|------|------|------|------|-----|------|------|
|             |        |                                      | Min. | Max. | Min. | Max. | Min | Max. |      |
| READ CYCLE  |        |                                      |      |      |      |      |     |      |      |
| 1           | Trc    | Read Cycle Time                      | 55   | -    | 70   | -    | 85  | -    | ns   |
| 2           | TAA    | Address Access Time                  | -    | 55   | -    | 70   | -   | 85   | ns   |
| 3           | TACS   | Chip Select Access Time              | -    | 55   | -    | 70   | -   | 85   | ns   |
| 4           | TOE    | Output Enable to Output Valid        | -    | 25   | -    | 35   | -   | 45   | ns   |
| 5           | TCLZ   | Chip Select to Output in Low Z       | 10   | -    | 10   | -    | 10  | -    | ns   |
| 6           | TOLZ   | Output Enable to Output in Low Z     | 5    | -    | 5    | -    | 5   | -    | ns   |
| 7           | TCHZ   | Chip Deselection to Output in High Z | 0    | 20   | 0    | 25   | 0   | 30   | ns   |
| 8           | TOHZ   | Out Disable to Output in High Z      | 0    | 20   | 0    | 25   | 0   | 30   | ns   |
| 9           | tOH    | Output Hold from Address Change      | 10   | -    | 10   | -    | 10  | -    | ns   |
| WRITE CYCLE |        |                                      |      |      |      |      |     |      |      |
| 10          | tWC    | Write Cycle Time                     | 55   | -    | 70   | -    | 85  | -    | ns   |
| 11          | tCW    | Chip Selection to End of Write       | 45   | -    | 60   | -    | 70  | -    | ns   |
| 12          | tAW    | Address Valid to End of Write        | 45   | -    | 60   | -    | 70  | -    | ns   |
| 13          | tAS    | Address Set-up Time                  | 0    | -    | 0    | -    | 0   | -    | ns   |
| 14          | tWP    | Write Pulse Width                    | 40   | -    | 50   | -    | 55  | -    | ns   |
| 15          | tWR    | Write Recovery Time                  | 0    | -    | 0    | -    | 0   | -    | ns   |
| 16          | tWHZ   | Write to Output in High Z            | 0    | 20   | 0    | 25   | 0   | 30   | ns   |
| 17          | tDW    | Data to Write Time Overlap           | 25   | -    | 30   | -    | 35  | -    | ns   |
| 18          | tDH    | Data Hold from Write Time            | 0    | -    | 0    | -    | 0   | -    | ns   |
| 19          | tOW    | Output Active from End of Write      | 5    | -    | 5    | -    | 5   | -    | ns   |

## AC TEST CONDITIONS

TA = 0°C to 70°C (Normal) unless otherwise specified

| PARAMETER                               | Value                  |
|---|------------------------|
| Input Pulse Level                       | 0.8V to 2.4V           |
| Input Rise and Fall Time                | 5ns                    |
| Input and Output Timing Reference Level | 1.5V                   |
| Output Load                             | CL = 100pF + 1TTL Load |

## AC TEST LOADS

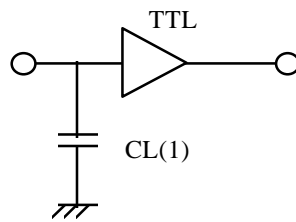

Note : Including jig and scope capacitance

## CAPACITANCE

Temp = 25°C, f = 1.0MHz

| Symbol | Parameter          | Condition | Max. | Unit |
|--------|--------------------|-----------|------|------|
| CIN    | Input Capacitance  | VIN = 0V  | 6    | pF   |
| COUT   | Output Capacitance | VI/O = 0V | 8    | pF   |

Note : This parameter is sampled and not 100% tested

**TIMING DIAGRAM**

**READ CYCLE 1**

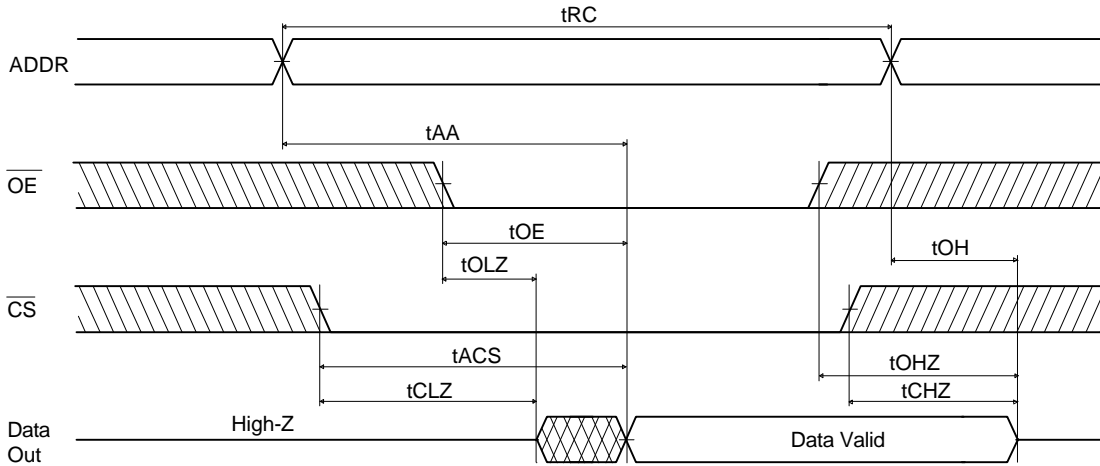

Note(READ CYCLE):

1.  $t_{CHZ}$  and  $t_{OHZ}$  are defined as the time at which the outputs achieve the open circuit conditions and are not referenced to output voltage levels
2. At any given temperature and voltage condition,  $t_{CHZ}$  max. is less than  $t_{CLZ}$  min. both for a given device and from device to device.
3.  $\overline{WE}$  is high for the read cycle.

**READ CYCLE 2**

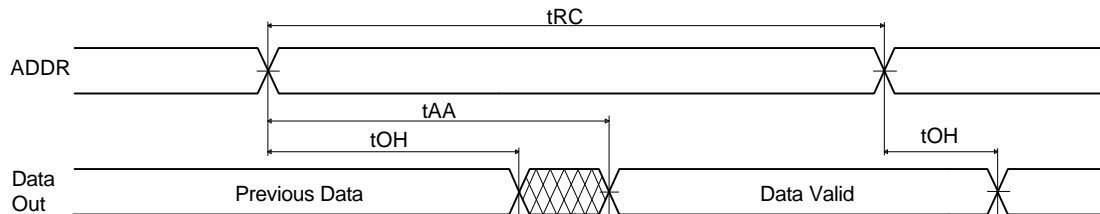

Note(READ CYCLE):

1.  $\overline{WE}$  is high for the read cycle.
2. Device is continuously selected  $\overline{CS} = V_{IL}$ .
3.  $\overline{OE} = V_{IL}$ .

**WRITE CYCLE 1 (/OE Clocked)**

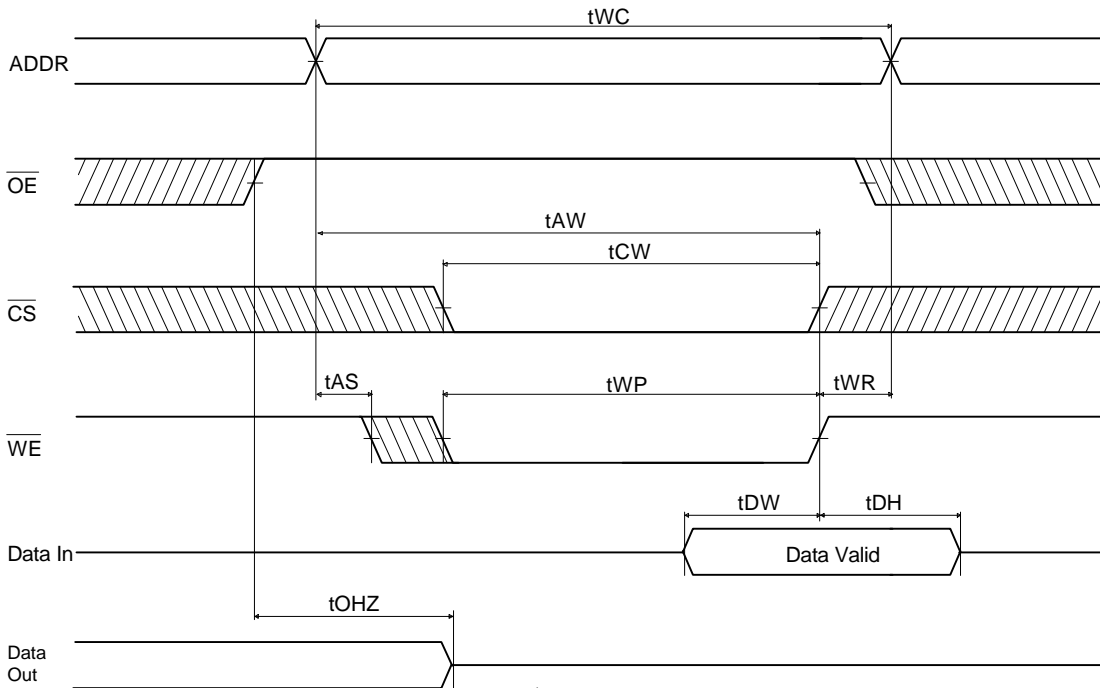

**WRITE CYCLE 2 (/OE Low Fixed)**

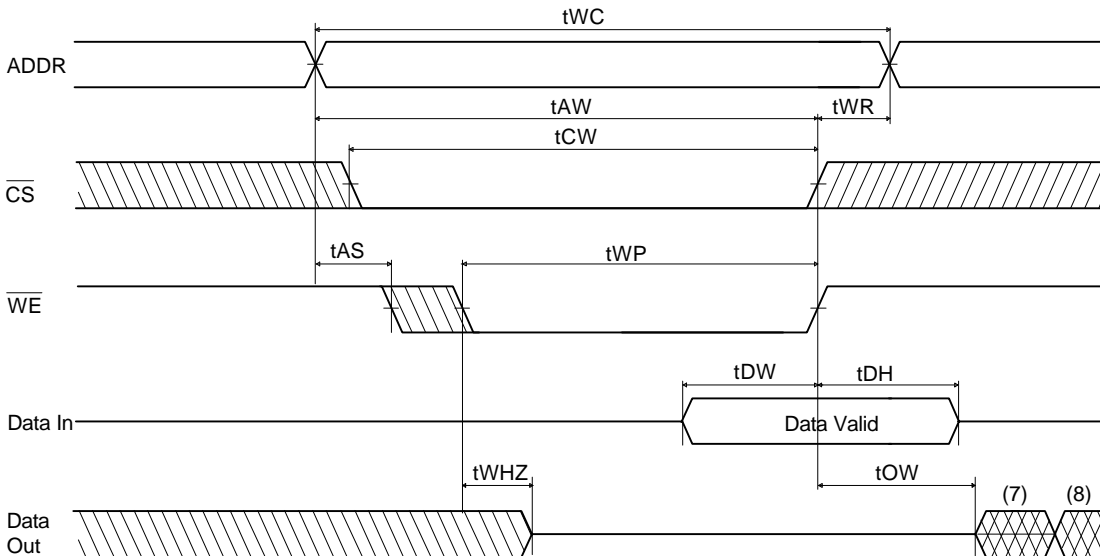

**Notes(WRITE CYCLE):**

1. A write occurs during the overlap of a low /CS and low /WE. A write begins at the latest transition among /CS going low /WE going low: A write end at the earliest transition among /CS going high and /WE going high.  $t_{WP}$  is measured from the beginning of write to the end of write.
2.  $t_{CW}$  is measured from the later of /CS going low to the end of write.
3.  $t_{AS}$  is measured from the address valid to the beginning of write.
4.  $t_{WR}$  is measured from the end of write to the address change.
5. If /OE and /WE are in the read mode during this period, and the I/O pins are in the output low-Z state. Inputs of opposite phase of the output must not be applied because bus contention can occur.
6. If /CS goes low simultaneously with /WE going low, the outputs remain in high impedance state.
7. Dout is the read data of the new address.
8. When /CS is low, I/O pins are in the output state. The input signals in the opposite phase leading to the outputs should not be applied.

### DATA RETENTION ELECTRIC CHARACTERISTIC

TA=0°C to 70°C (Normal)

| Symbol | Parameter                            |          | Test Condition                                     | Min    | Typ | Max | Unit |
|--------|--------------------------------------|----------|--|--------|-----|-----|------|
| VDR    | Vcc for Data Retention               |          | /CS ≥ Vcc - 0.2V<br>Vss ≤ VIN ≤ Vcc                | 2.0    | -   | -   | V    |
| ICCDR  | Data Retention Current               | HY628400 | Vcc = 3.0V,<br>/CS ≥ Vcc - 0.2V<br>Vss ≤ VIN ≤ Vcc | L      | -   | 50  | uA   |
|        |                                      |          |  | LL     | -   | 15  | uA   |
| tCDR   | Chip Deselect to Data Retention Time |          |  | 0      | -   | -   | ns   |
| tR     | Operating Recovery Time              |          |  | tRC(2) | -   | -   | ns   |

Notes:

1. Typical values are at the condition of TA = 25°C.
2. tRC is read cycle time.

### DATA RETENTION TIMING DIAGRAM

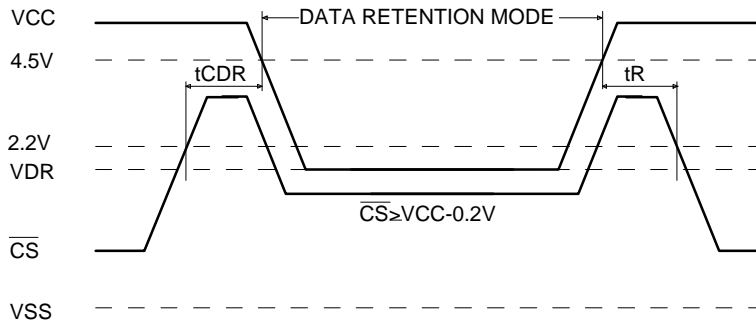

### RELIABILITY SPEC.

| TEST MODE  |     | TEST SPEC. |
|------------|-----|------------|
| ESD        | HBM | ≥ 2000V    |
|            | MM  | ≥ 250V     |
| LATCH - UP |     | ≤ -100mA   |
|            |     | ≥ 100mA    |

### PACKAGE INFORMATION

32pin 400mil Thin Small Outline Package Standard(T2)

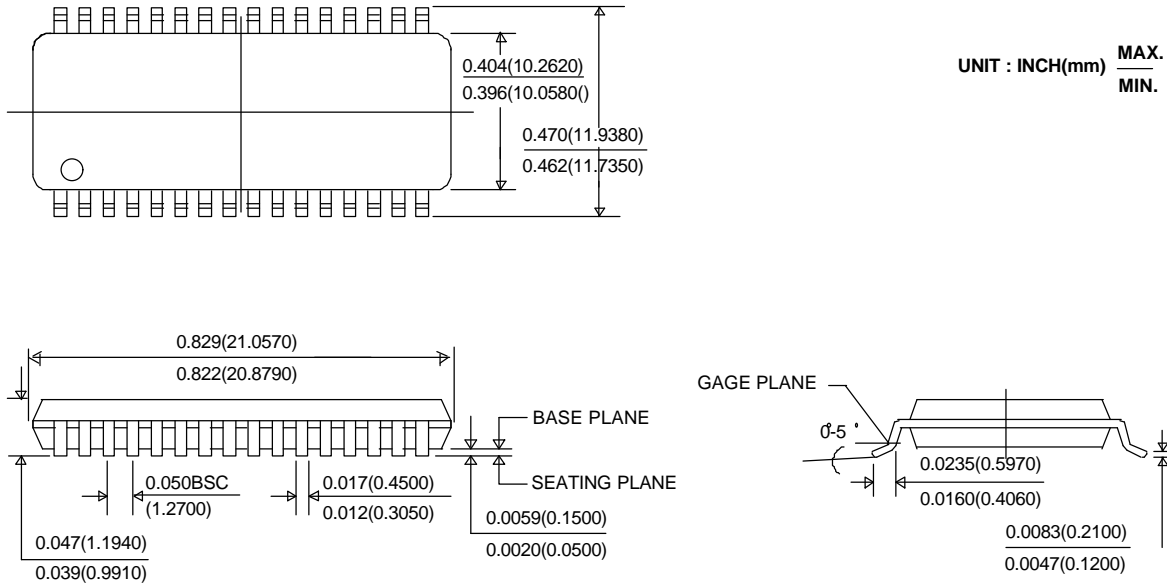

32pin 400mil Thin Small Outline Package Reversed(R2)

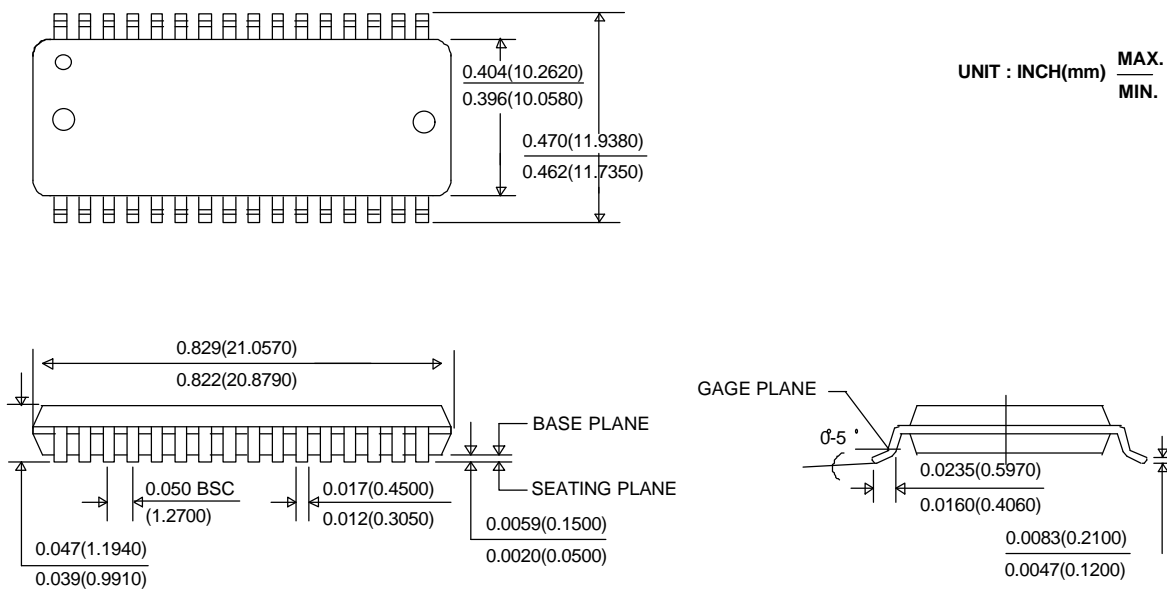



32pin 525mil Small Outline Package(G)

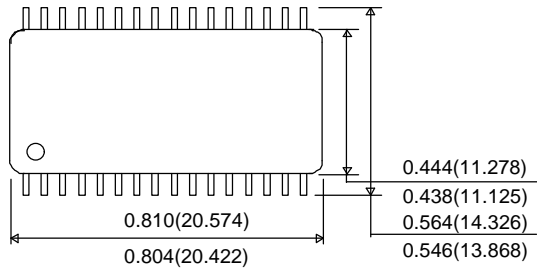

UNIT : INCH(mm)

