

Ultracell®

'Quality in Every Language'

UCG200-12

12V 200Ah (C₁₀)

12V 230Ah (C₁₀₀)

Solar Series

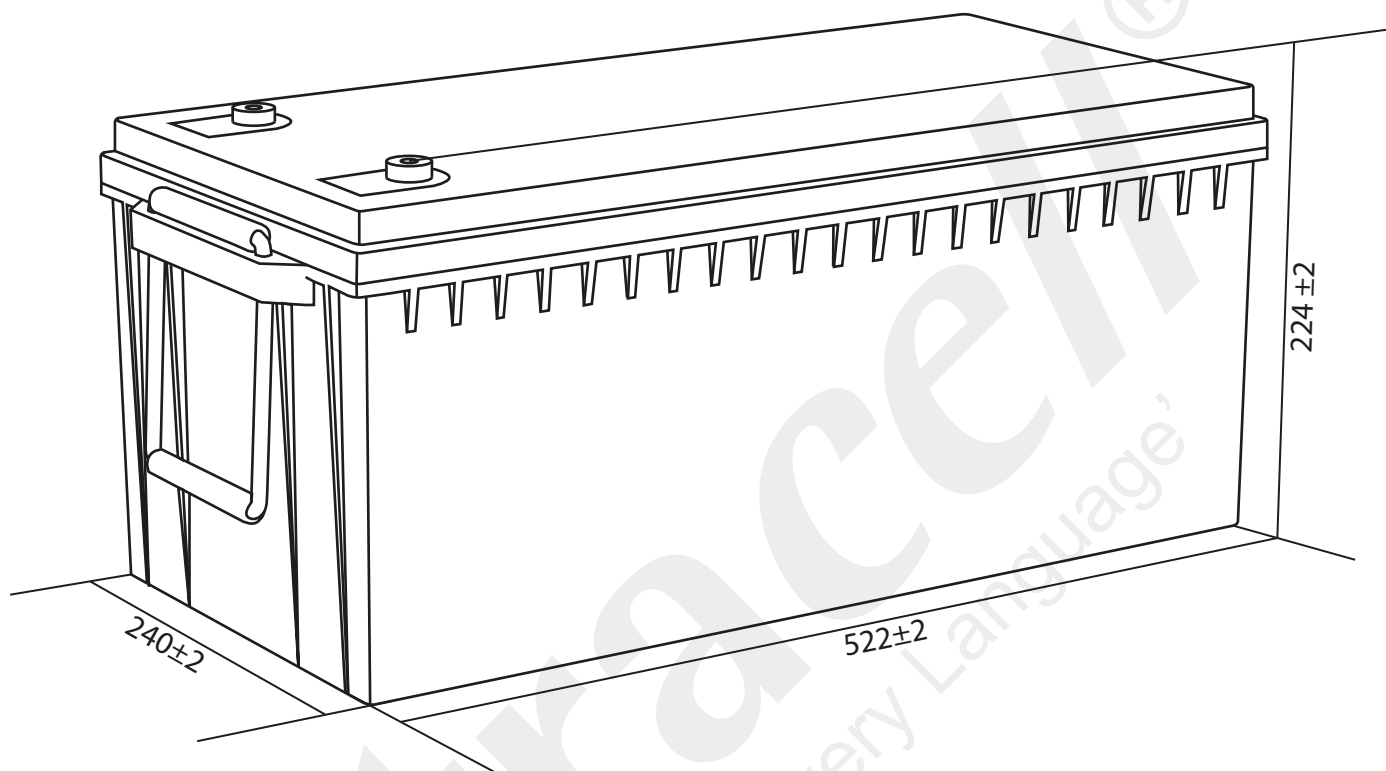

Technical Dimensions (mm)

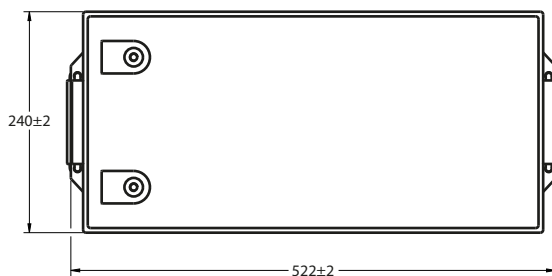
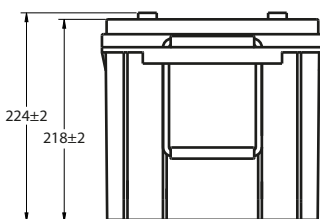
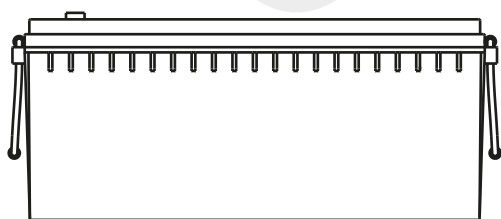



Image



Terminal Dimensions (mm)

Standard Terminal: F11

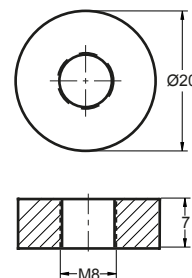

Technical Specification

Output	Nominal Voltage	12V
	Nominal Capacity (10HR)	200Ah
Terminal Type	Standard Terminal	F11
Container Material	Standard Option	ABS
	Flame Retardant Option (FR)	ABS (UL94:VO)
Rated Capacity	(100HR 1.80V/cell, 25°C)	230 Ah/2.30A
	(20HR 1.80V/cell, 25°C)	206 Ah/10.3A
	(10HR 1.80V/cell, 25°C)	200 Ah/20.0A
	(5HR 1.75V/cell, 25°C)	170 Ah/34.0A
	(3HR 1.75V/cell, 25°C)	147.6 Ah/49.2A
	(1HR 1.60V/cell, 25°C)	119.4 Ah/119.4A
Max Discharge Current	2000A (5s)	
Internal Resistance	Approx 2.9mΩ	
Discharge Characteristics	Operating Temp Range	Discharge: -15 ~ 50°C Charge: 0 ~ 40°C Storage: -15 ~ 40°C
	Nominal Operating Temp Range	25 ± 3°C
	Cycle Use	Initial Charging Current less than 60A. Voltage 14.4V ~ 15.0V @ 25°C Temp. Coefficient -30mV/°C
	Standby Use	No limit on initial charging current. Voltage 13.5V ~ 13.8V @ 25°C Temp. Coefficient -20mV/°C
	Capacity affected by Temperature	40°C 103% 25°C 100% 0°C 86%
Design Floating Life at 20°C	15 Years	

Self Discharge

Ultracell® UCG batteries may be stored for up to 6 months at 25°C and then a refresh charge is required. For higher temperatures the time intervals will be shorter.

Constant Current Discharge / Constant Power Discharge At 25°C (Amperes & Watts/Cell)

A = Amperes W = Watts

F.V/TIME	5 min	10 min	15 min	20 min	30 min	45 min	60 min	2 hours	3 hours	4 hours	5 hours	6 hours	8 hours	10 hours	20 hours
A	W	W	W	W	W	W	W	W	W	W	W	W	W	W	W
1.85V/cell	322.4	253.5	215.6	180.3	142.5	108.2	89.5	56.9	44.2	36.4	30.9	26.9	21.9	18.6	10.0
	594.1	471.9	405.4	342.5	273.0	209.0	173.5	110.9	86.5	71.3	60.7	53.1	43.4	36.9	19.9
1.80V/cell	426.5	319.2	256.7	210.0	164.0	122.8	99.6	61.9	47.5	38.7	33.2	28.9	23.4	20.0	10.3
	778.1	587.6	476.5	393.4	310.4	235.3	192.0	119.9	92.4	75.6	65.0	56.8	46.1	39.7	20.5
1.75V/cell	490.8	358.0	286.1	230.6	174.8	129.9	105.4	64.8	49.2	40.0	34.0	29.7	23.8	20.2	10.4
	875.6	647.9	524.3	427.5	328.0	246.8	202.1	125.2	95.5	77.9	66.4	58.2	46.8	40.0	20.6
1.70V/cell	546.8	394.7	309.1	245.2	184.4	136.4	110.0	68.0	50.9	41.2	34.9	30.3	24.1	20.3	10.6
	947.0	697.2	557.6	450.4	343.5	257.7	210.1	130.9	98.5	80.0	68.0	59.3	47.4	40.2	21.0
1.65V/cell	597.2	421.9	325.5	258.0	193.1	140.5	113.9	69.9	52.8	42.4	35.7	31.0	24.5	20.5	10.7
	1017.5	736.9	581.5	469.4	356.5	263.3	216.1	133.7	101.7	82.1	69.4	60.4	48.0	40.5	21.2
1.60V/cell	664.0	461.8	350.9	277.1	205.2	148.5	119.4	72.5	54.7	43.4	36.4	31.6	24.8	20.8	10.8
	1105.2	788.1	616.6	498.6	375.7	276.6	225.4	138.0	104.8	83.7	70.5	61.5	48.5	41.1	21.3

Discharge Characteristics

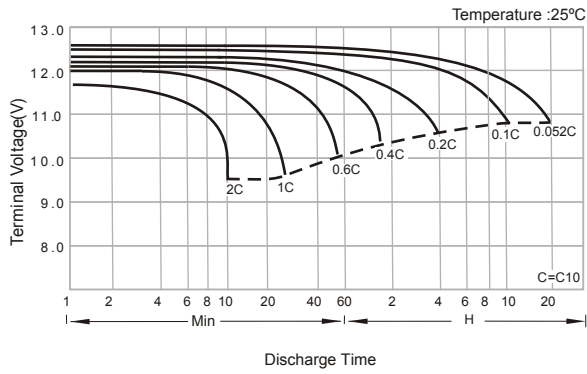

Float Charging Characteristics

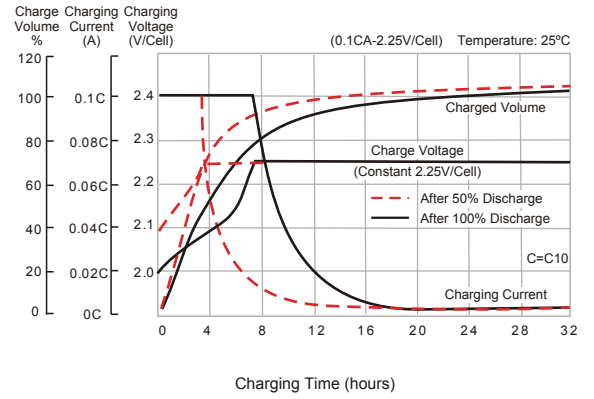

Temperature Effects in Relation to Battery Capacity

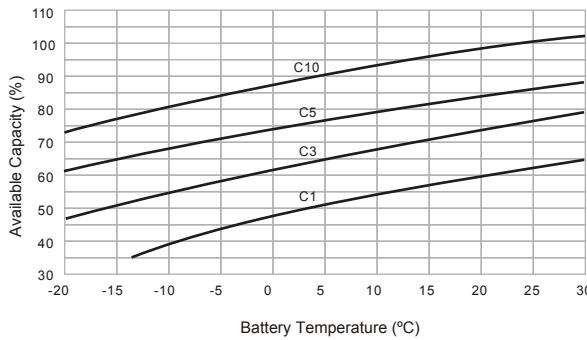

Effect of Temperature on Long Term Float Life

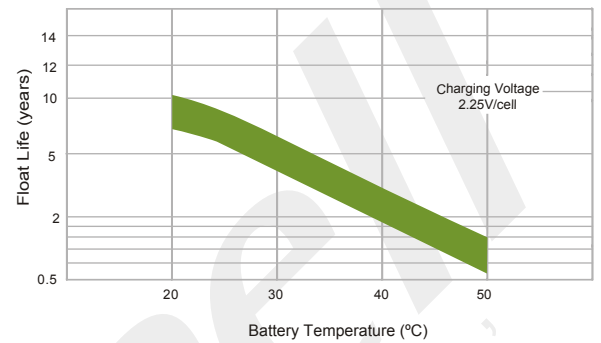

UCG200-12
12V 200Ah (C₁₀)
12V 230Ah (C₁₀₀)
Solar Series

Cycle Life in Relation to Depth of Discharge

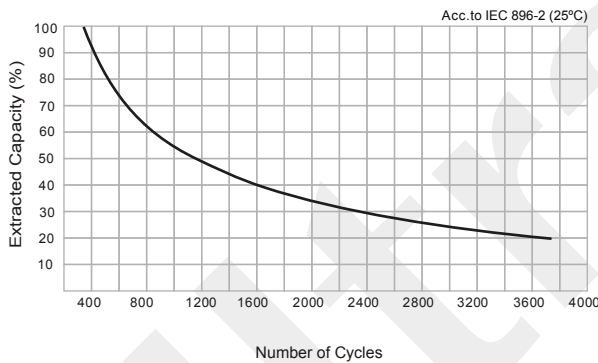

General Relation of Capacity vs. Storage Time

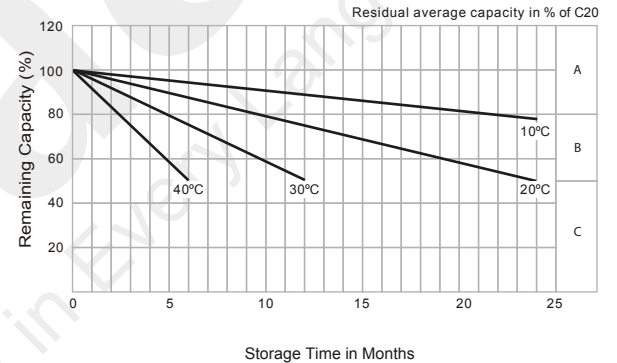

General Relation of Capacity vs. Storage Time (Notes)

- A) No supplementary charge required.
(Carryout supplementary charge before use if 100% capacity is required.)
- B) Supplementary charge required before use. Optional charging way as below:
 1. Charged for above 3 days at limited current 0.25CA and constant voltage 2.25V/cell.
 2. Charged for above 20 hours at limited current 0.25CA and constant voltage 2.25V/cell.
 3. Charged for 8 ~ 10 hours at limited current 0.05 CA.
- C) Supplementary charge may often fail to recover the capacity.
The battery should never be left standing till this is reached.

