

# Ultracell®

'Quality in Every Language'

UCG150-12

12V 150Ah (C<sub>10</sub>)

12V 172Ah (C<sub>100</sub>)

Solar Series

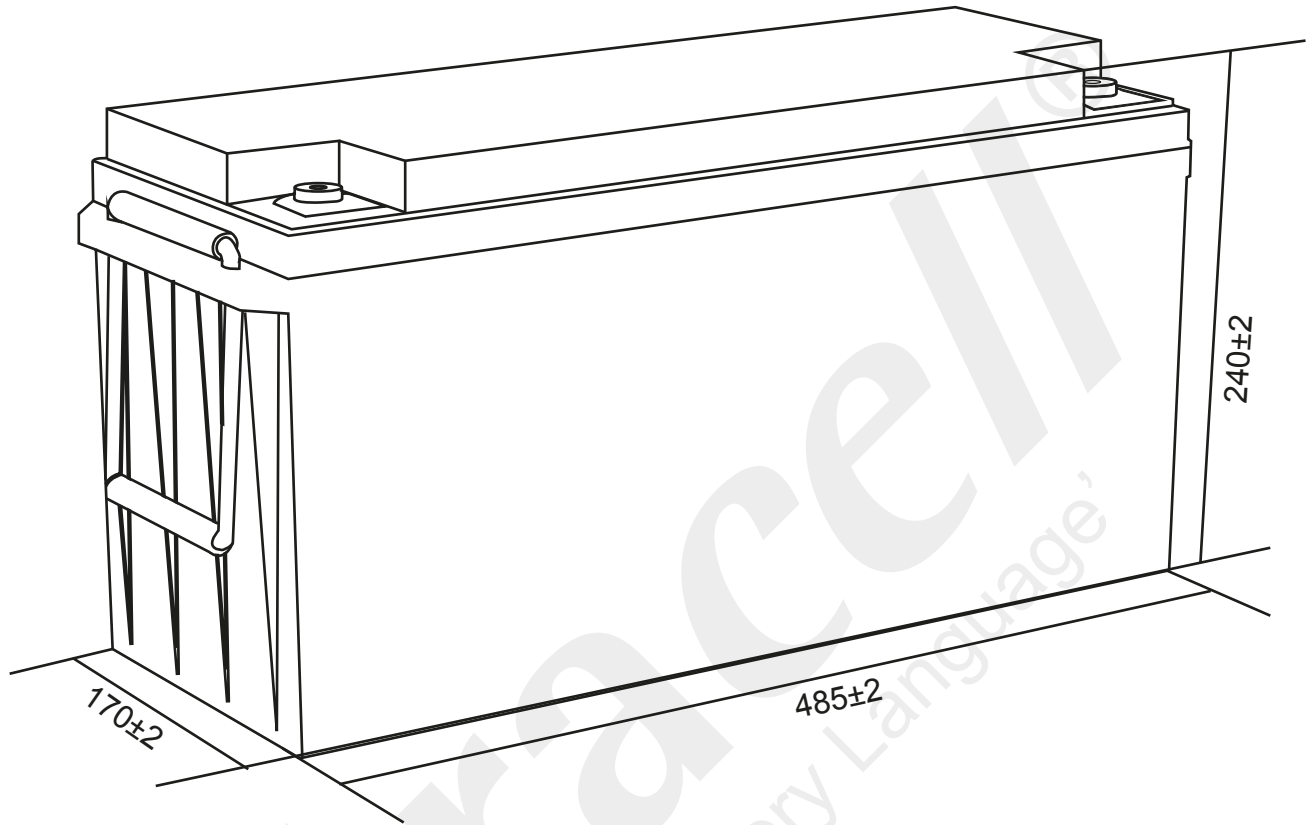

## Technical Dimensions (mm)

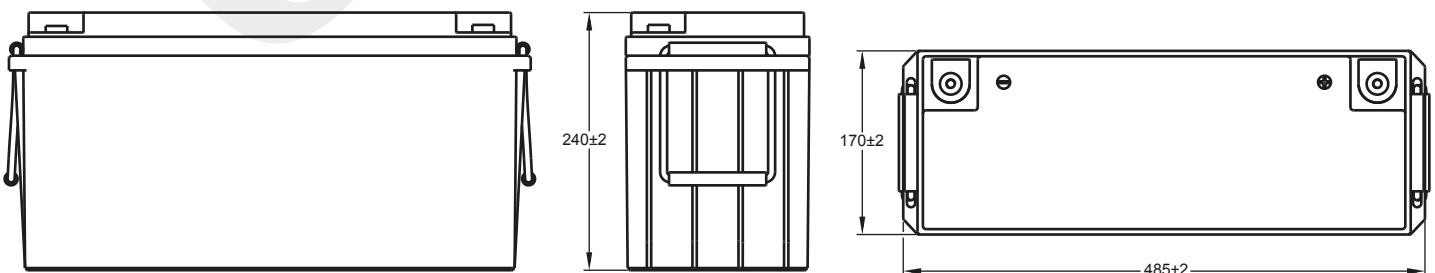



Image



Terminal Dimensions (mm)

Standard Terminal: F11

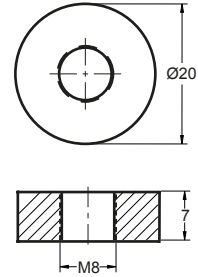

Technical Specification

<b>Output</b>	Nominal Voltage	12V
	Nominal Capacity (10HR)	150Ah
<b>Terminal Type</b>	Standard Terminal	F11
<b>Container Material</b>	Standard Option	ABS
	Flame Retardant Option (FR)	ABS (UL94:VO)
<b>Rated Capacity</b>	(100HR 1.80V/cell, 25°C)	172 Ah/1.72A
	(20HR 1.80V/cell, 25°C)	154.6 Ah/7.73A
	(10HR 1.80V/cell, 25°C)	150.0 Ah/15.0A
	(5HR 1.75V/cell, 25°C)	127.5 Ah/25.5A
	(3HR 1.75V/cell, 25°C)	110.7 Ah/36.9A
	(1HR 1.60V/cell, 25°C)	89.6 Ah/89.6A
<b>Max Discharge Current</b>	1500A (5s)	
<b>Internal Resistance</b>	Approx 3.7mΩ	
<b>Discharge Characteristics</b>	Operating Temp Range	Discharge: -15 ~ 50°C Charge: 0 ~ 40°C Storage: -15 ~ 40°C
	Nominal Operating Temp Range	25 ± 3°C
	Cycle Use	Initial Charging Current less than 45.0A. Voltage 14.4V ~ 15.0V @ 25°C Temp. Coefficient -30mV/°C
	Standby Use	No limit on initial charging current. Voltage 13.5V ~ 13.8V @ 25°C Temp. Coefficient -20mV/°C
	Capacity affected by Temperature	40°C 103% 25°C 100% 0°C 86%
<b>Design Floating Life at 20°C</b>	15 Years	

Self Discharge

Ultracell® UCG batteries may be stored for up to 6 months at 25°C and then a refresh charge is required. For higher temperatures the time intervals will be shorter.

Constant Current Discharge / Constant Power Discharge At 25°C (Amperes & Watts/Cell)

A = Amperes W = Watts

F.V/TIME	5 min	10 min	15 min	20 min	30 min	45 min	60 min	2 hours	3 hours	4 hours	5 hours	6 hours	8 hours	10 hours	20 hours
A	W	W	W	W	W	W	W	W	W	W	W	W	W	W	W
1.85V/cell	241.8	190.1	161.7	135.2	106.9	81.2	67.2	42.7	33.2	27.3	23.2	20.2	16.43	13.92	7.50
	445.6	353.9	304.0	256.9	204.8	156.7	130.1	83.2	64.8	53.5	45.6	39.8	32.6	27.7	14.91
1.80V/cell	319.9	239.4	192.5	157.5	123.0	92.1	74.7	46.4	35.6	29.0	24.9	21.7	17.51	15.00	7.73
	583.6	440.7	357.4	295.1	232.8	176.5	144.0	89.9	69.3	56.7	48.8	42.6	34.6	29.7	15.34
1.75V/cell	368.1	268.5	214.6	173.0	131.1	97.4	79.0	48.6	36.9	30.0	25.5	22.3	17.81	15.15	7.80
	656.7	486.0	393.2	320.6	246.0	185.1	151.6	93.9	71.6	58.4	49.8	43.6	35.1	30.0	15.47
1.70V/cell	410.1	296.1	231.8	183.9	138.3	102.3	82.5	51.0	38.2	30.9	26.2	22.7	18.06	15.23	7.95
	710.2	522.9	418.2	337.8	257.6	193.3	157.6	98.2	73.9	60.0	51.0	44.5	35.6	30.1	15.75
1.65V/cell	447.9	316.4	244.1	193.5	144.8	105.4	85.4	52.4	39.6	31.8	26.8	23.2	18.34	15.38	8.03
	763.1	552.7	436.1	352.1	267.3	197.5	162.1	100.3	76.3	61.6	52.0	45.3	36.0	30.4	15.89
1.60V/cell	498.0	346.3	263.2	207.8	153.9	111.4	89.6	54.3	41.0	32.6	27.3	23.7	18.56	15.63	8.10
	828.9	591.1	462.4	373.9	281.7	207.5	169.0	103.5	78.6	62.8	52.9	46.1	36.4	30.8	16.01



### Discharge Characteristics

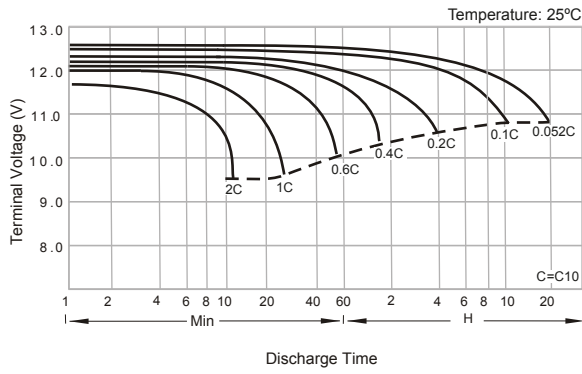

### Float Charging Characteristics

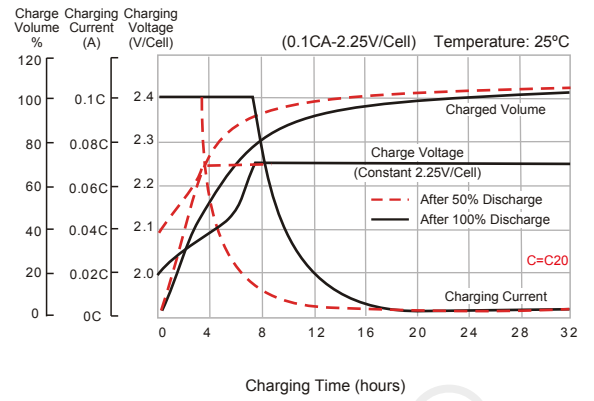

### Temperature Effects in Relation to Battery Capacity

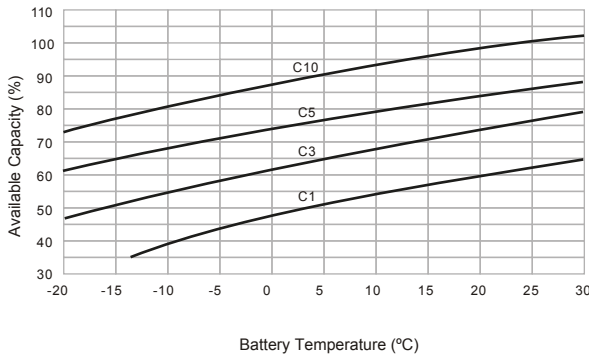

### Effect of Temperature on Long Term Float Life

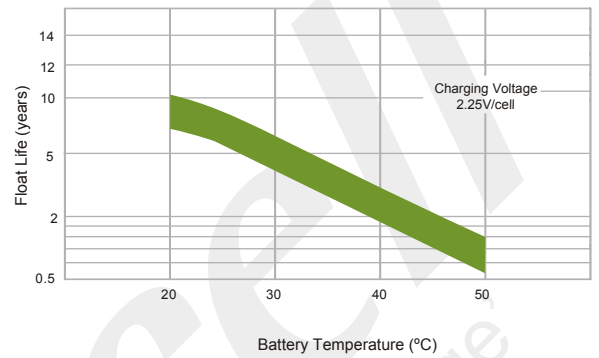

### Cycle Life in Relation to Depth of Discharge

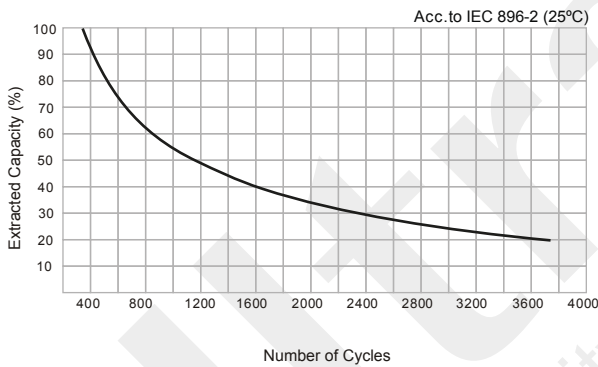

### General Relation of Capacity vs. Storage Time

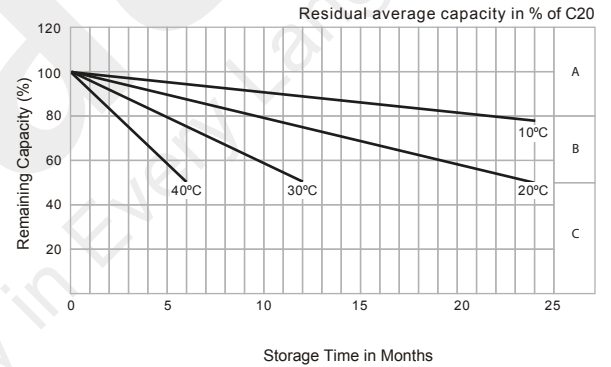

### General Relation of Capacity vs. Storage Time (Notes)

- A) No supplementary charge required.  
(Carryout supplementary charge before use if 100% capacity is required.)
- B) Supplementary charge required before use. Optional charging way as below:
  1. Charged for above 3 days at limited current 0.25CA and constant voltage 2.25V/cell.
  2. Charged for above 20 hours at limited current 0.25CA and constant voltage 2.25V/cell.
  3. Charged for 8 ~ 10 hours at limited current 0.05 CA.
- C) Supplementary charge may often fail to recover the capacity.  
The battery should never be left standing till this is reached.