

# MEK1S Series

1W, Unregulated Single or Dual Output, 3KV Isolation, SIP7 Package DC/DC Converters

## Features

- ▶ Rated power: 1W Max
- ▶ Input voltage range  $\pm 10\%$
- ▶ Unregulated output
- ▶ High efficiency, up to 89%
- ▶ Small no load input current
- ▶ Isolation voltage 3KVDC
- ▶ Operating temperature range:  $-40 \sim +105^{\circ}\text{C}$  ambient
- ▶ RoHS compliant
- ▶ Compact SIP7 package
- ▶ Continuous short circuit protection
- ▶ Designed to meet EN/IEC 62368-1
- ▶ 3 year warranty



## Overview

The MEK1S series are unregulated SIP7 package DC/DC converters with single or dual outputs, and 3KVDC isolation. These converters feature high efficiency, low ripple and noise, continuous short circuit protection, and wide operating temperature range. They are widely used in distributed power system in industrial applications where isolation and voltage converting is needed.

## Model Numbers

Model Number	Input Voltage [VDC] $\pm 10\%$	Output Voltage [VDC]	Output Current [mA]		Efficiency [%] Typ.	Capacitive Load [ $\mu\text{F}$ ] Max.
			Max.	Min.		
MEK1S-0303	3.3	3.3	303	30	82	4000
MEK1S-0305	3.3	5	200	20	83	4000
MEK1S-0309	3.3	9	111	11	84	2000
MEK1S-0312	3.3	12	84	8	85	1000
MEK1S-0315	3.3	15	67	7	85	680
MEK1S-0324	3.3	24	42	4	84	560
MEK1S-0503	5	3.3	303	30	83	4000
MEK1S-0505	5	5	200	20	86	4000
MEK1S-0509	5	9	111	12	86	2000
MEK1S-0512	5	12	84	9	88	1000
MEK1S-0515	5	15	67	7	88	680
MEK1S-0524	5	24	42	4	89	560
MEK1S-0503D	5	$\pm 3.3$	$\pm 152$	$\pm 15$	84	2000
MEK1S-0505D	5	$\pm 5$	$\pm 100$	$\pm 10$	86	2000
MEK1S-0509D	5	$\pm 9$	$\pm 56$	$\pm 6$	86	1000
MEK1S-0512D	5	$\pm 12$	$\pm 42$	$\pm 5$	88	560
MEK1S-0515D	5	$\pm 15$	$\pm 34$	$\pm 4$	88	220
MEK1S-0524D	5	$\pm 24$	$\pm 21$	$\pm 3$	88	100

# MEK1S Series

1W, Unregulated Single or Dual Output, 3KV Isolation, SIP7 Package DC/DC Converters

## Model Numbers [continued]

Model Number	Input Voltage [VDC] $\pm 10\%$	Output Voltage [VDC]	Output Current [mA]		Efficiency [%] Typ.	Capacitive Load [ $\mu$ F] Max.
			Max.	Min.		
MEK1S-1203	12	3.3	303	30	84	4000
MEK1S-1205	12	5	200	20	86	4000
MEK1S-1209	12	9	111	12	87	2000
MEK1S-1212	12	12	84	9	87	1000
MEK1S-1215	12	15	67	7	88	680
MEK1S-1224	12	24	42	5	89	560
MEK1S-1203D	12	$\pm 3.3$	$\pm 152$	$\pm 15$	84	2000
MEK1S-1205D	12	$\pm 5$	$\pm 100$	$\pm 10$	86	2000
MEK1S-1209D	12	$\pm 9$	$\pm 56$	$\pm 5$	87	1000
MEK1S-1212D	12	$\pm 12$	$\pm 42$	$\pm 5$	87	560
MEK1S-1215D	12	$\pm 15$	$\pm 34$	$\pm 4$	88	220
MEK1S-1224D	12	$\pm 24$	$\pm 21$	$\pm 3$	84	100
MEK1S-1505	15	5	200	20	86	4000
MEK1S-1509	15	9	111	12	87	2000
MEK1S-1512	15	12	84	9	87	1000
MEK1S-1515	15	15	67	7	88	680
MEK1S-1524	15	24	42	5	84	560
MEK1S-1505D	15	$\pm 5$	$\pm 100$	$\pm 10$	86	2000
MEK1S-1512D	15	$\pm 12$	$\pm 42$	$\pm 5$	87	560
MEK1S-1515D	15	$\pm 15$	$\pm 34$	$\pm 4$	88	220
MEK1S-1524D	15	$\pm 24$	$\pm 21$	$\pm 2$	84	100
MEK1S-2403	24	3.3	303	30	84	4000
MEK1S-2405	24	5	200	20	87	4000
MEK1S-2409	24	9	111	12	88	2000
MEK1S-2412	24	12	84	9	88	1000
MEK1S-2415	24	15	67	7	88	680
MEK1S-2424	24	24	42	5	89	560
MEK1S-2405D	24	$\pm 5$	$\pm 100$	$\pm 10$	87	2000
MEK1S-2409D	24	$\pm 9$	$\pm 56$	$\pm 5$	88	1000
MEK1S-2412D	24	$\pm 12$	$\pm 42$	$\pm 5$	88	560
MEK1S-2415D	24	$\pm 15$	$\pm 34$	$\pm 4$	88	220
MEK1S-2424D	24	$\pm 24$	$\pm 21$	$\pm 3$	84	100

\* Only typical models are listed. Other models may be available upon request.

\* For dual output models, max capacitive load stipulated in the above list is for each output.

### Electrical Specifications

Unless otherwise indicated, specifications are measured at  $T_A=25^{\circ}\text{C}$ , nominal input voltage, full load after warm up.

Parameters	Conditions	Min.	Typ.	Max.	Unit	Note
Input current Full load	$V_{IN}=3.3\text{V}$		370		mA	
	$V_{IN}=5\text{V}$	-	235	-		
	$V_{IN}=12\text{V}$		99			
	$V_{IN}=24\text{V}$		51			
Input current No load		-	3	15	mA	
Reflected Ripple Current		-	15	-	mA	
Surge voltage 1 second max	$V_{IN}=3.3\text{V}$	-0.7		5	VDC	
	$V_{IN}=5\text{V}$	-0.7		9		
	$V_{IN}=12\text{V}$	-0.7	-	18		
	$V_{IN}=15\text{V}$	-0.7		21		
	$V_{IN}=24\text{V}$	-0.7		30		
Output voltage accuracy	All models	Refer to graphic in "Characteristic Curves" section				
Line regulation For $V_{IN}$ change of $\pm 1\%$	$V_{OUT}=3.3\text{V}$	-	-	$\pm 1.5$	%	
	All others			$\pm 1.2$		
Load regulation $I_{OUT}=10\%$ to $100\%$ of $I_{OUT, rated}$	$V_{OUT}=3.3\text{V}$		10		%	
	$V_{OUT}=5\text{V}$		8			
	$V_{OUT}=9\text{V}$	-	8	-		
	$V_{OUT}=12\text{V}$		7			
	$V_{OUT}=15\text{V}$		6			
	$V_{OUT}=24\text{V}$		6			
Output ripple and noise	20MHz bandwidth	-	45	100	mVp-p	
Temperature coefficient	Full load	-	$\pm 0.03$	-	$\%/^{\circ}\text{C}$	
Output short circuit protection		Continuous, automatic recovery				
Input filter		Capacitor				
Hot plug		None				

\* Operating with less than 10% of rated load will not cause permanent damage to the converters, but the performances data may not fall into the specifications, and reliable operating is not assured.

\* Dual output models need to operate with balanced load. The load difference between two outputs over 10% may cause unstable operating of the converter.

## General Specifications

Parameters	Conditions	Min.	Typ.	Max.	Unit	Note
<b>Isolation voltage</b> Tested for 1 minute, leakage current less than 1mA	Input to Output	3000	-	-	VDC	
<b>Isolation resistance</b> Tested at 500VDC	Input to Output	1000	-	-	M ohm	
<b>Isolation capacitance</b> Tested at 100KHz, 0.1V	Input to Output	-	20	-	pF	
<b>Operating temperature</b>	See "Derating Curve"	-40	-	+105	°C	
<b>Storage temperature</b>		-55	-	+125	°C	
<b>Temperature rise at case</b>		-	25	-	°C	
<b>Storage humidity</b>	Non-condensing	5	-	95	%RH	
<b>Switching frequency</b>	Full load	-	220	-	KHz	
<b>Pin soldering resistance</b> 1.5mm away from case for 10 sec		-	-	300	°C	
<b>Case material</b>		Black plastic UL94-V0				
<b>Cooling method</b>		Free air convection				
<b>Vibration</b>		10-150Hz, 5G, 0.75mm along X, Y and Z				
<b>Design based on standards</b>		UL/EN/IEC 62368-1				
<b>Safety certifications</b>		EN/IEC 62368-1				
<b>EMC</b>	Emissions Immunity	CISPR32, EN55032 Class B* IEC/EN61000-4-2				
<b>MTBF</b>	MIL-HDBK-217F	>3,500,000 Hours, T <sub>A</sub> =25°C				
<b>Size</b>		19.65 x 6.0 x 10.16 mm				
<b>Weight</b>		2.1g Typ.				

\*External circuit is required in order to meet Class B, refer to Figure 2 in Recommended External Circuit

## Characteristic Curves

### Derating Curve

Output vs Ambient Temperature

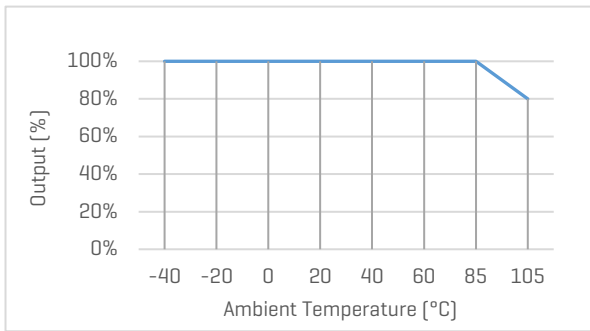

Output Voltage Accuracy vs Load

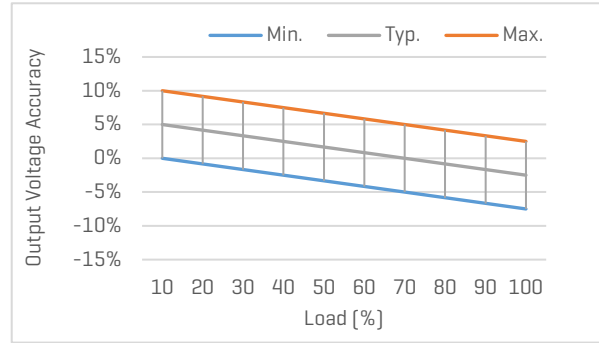

### Efficiency Curves

Efficiency vs Input Voltage

MEK1S-0505, with full Load

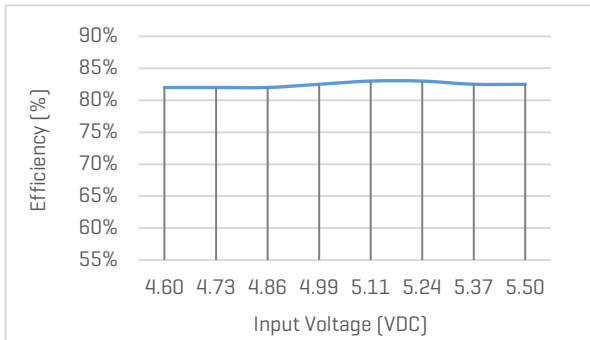

Efficiency vs Load

MEK1S-0505, with nominal input voltage

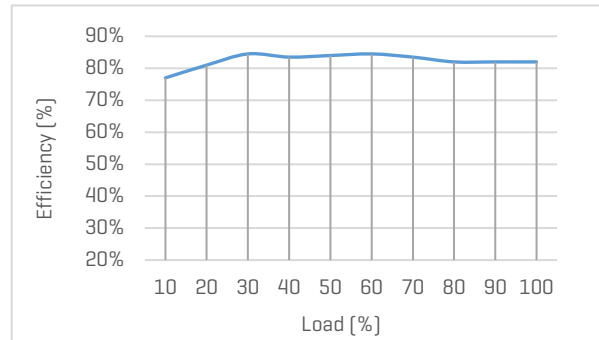

Efficiency vs Input Voltage

MEK1S-1205, with full Load

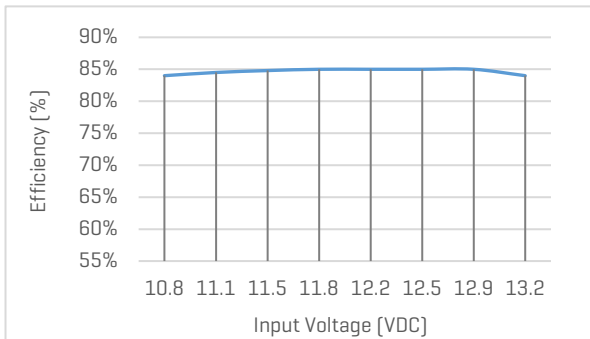

Efficiency vs Load

MEK1S-1205, with nominal input voltage

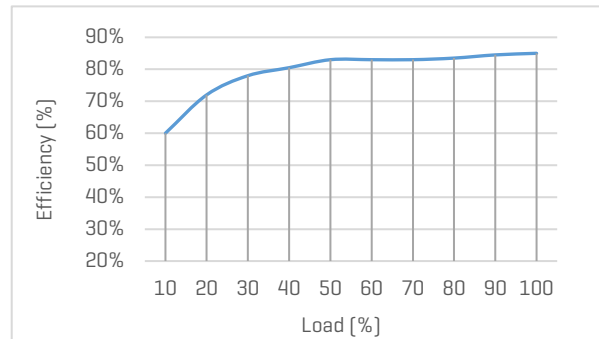

# MEK1S Series

1W, Unregulated Single or Dual Output, 3KV Isolation, SIP7 Package DC/DC Converters

## Recommended External Circuit

### Typical Application Circuit

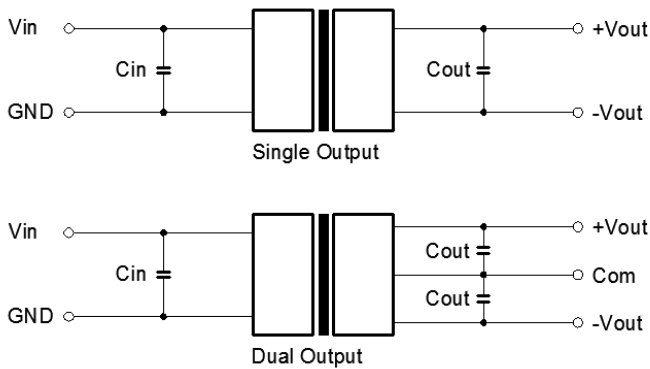

\*Typical application circuit is to further lower the input and output ripple. It is not required for general use.

\*Recommended component specifications are typical values. Excessive external capacitive load may cause startup problem.

Figure 1. Typical external circuit

[Table 1] Recommended component spec

Input voltage	3.3, 5V	12V	15V	24V
$C_{IN}$	4.7 $\mu$ F, 16V	2.2 $\mu$ F, 25V	2.2 $\mu$ F, 25V	1 $\mu$ F, 50V

[Table 2] Recommended component spec

Output voltage	3.3, 5V	9V	12V	15V	24V
$C_{OUT}$	10 $\mu$ F, 16V	4.7 $\mu$ F, 16V	2.2 $\mu$ F, 25V	1 $\mu$ F, 50V	0.47 $\mu$ F, 50V

### Circuit for EMC Enhancement

\*Use this application circuit to meet Class B EMC performance.

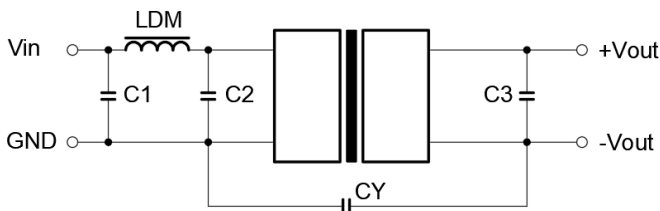

Figure 2. Circuit for EMC enhancement

[Table 3] Recommended component spec

Component	LDM	C1, C2	CY
Spec	6.8 $\mu$ H	4.7 $\mu$ F, 50V	1nF, 2KV

\*C3 refer to  $C_{OUT}$  in [Table 2]

## Mechanical Specifications

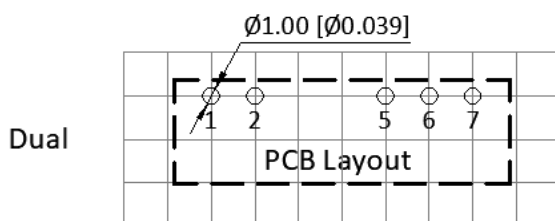
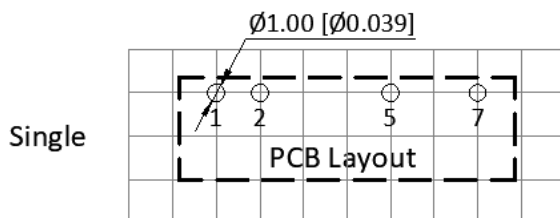
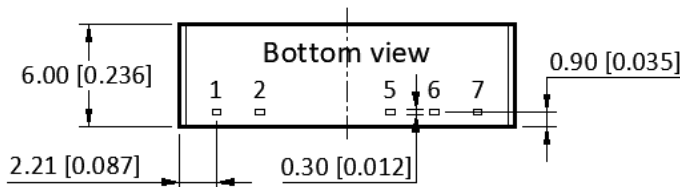
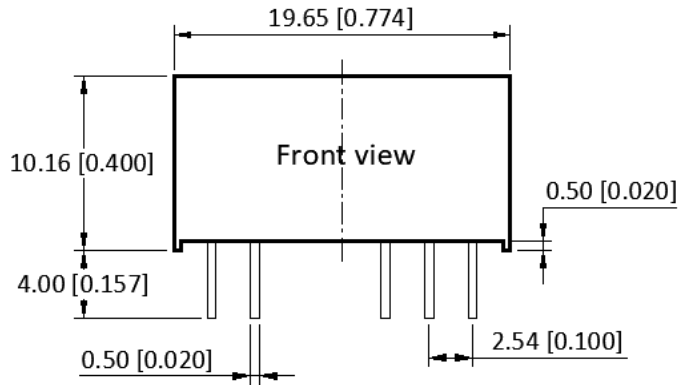

### Pin Definition

Pin #	Single Out	Dual Out
1	V <sub>IN</sub>	V <sub>IN</sub>
2	GND	GND
5	0V	-V <sub>OUT</sub>
6	No Pin	0V
7	+V <sub>OUT</sub>	+V <sub>OUT</sub>

\* Unless otherwise specified unit: mm [inch]

\* General tolerance: ±0.50 [±0.020]

\* Pin thickness: ±0.10 [±0.004]

\* Footprint grid 2.54 x 2.54 mm

### FAVOTEK LIMITED

#17 Canton Road, Tsim Sha Tsui, Kowloon, Hong Kong  
 Tel: +852 8191 6662  
 Eml: info@favotek.com

Favotek reserves the right to make changes to the product at any time without notice. Information provided by Favotek is believed to be accurate and reliable. However, no responsibility is assumed by Favotek for its use, nor for any infringements of patents or other rights of third parties which may result from its use.