

2MBI150NC-060

IGBT Module

600V / 150A 2 in one-package

■ Features

- High speed switching
- Voltage drive
- Low inductance module structure

■ Applications

- Inverter for Motor drive
- AC and DC Servo drive amplifier
- Uninterruptible power supply
- Industrial machines, such as Welding machines



■ Maximum ratings and characteristics

● Absolute maximum ratings (at $T_c=25^\circ\text{C}$ unless otherwise specified)

Item	Symbol	Rating	Unit
Collector-Emitter voltage	V_{CES}	600	V
Gate-Emitter voltage	V_{GES}	± 20	V
Collector current	Continuous	I_c	150 A
	1ms pulse	I_c pulse	300 A
	Continuous	$-I_c$	150 A
	1ms pulse	$-I_c$ pulse	300 A
Max. power dissipation	P_c	600	W
Operating temperature	T_j	+150	$^\circ\text{C}$
Storage temperature	T_{stg}	-40 to +125	$^\circ\text{C}$
Isolation voltage	V_{is}	AC 2500 (1min.)	V
Screw torque	Mounting *1	3.5	N·m
	Terminals *1	3.5	N·m

*1 : Recommendable value : 2.5 to 3.5 N·m(M5)

■ Equivalent Circuit Schematic

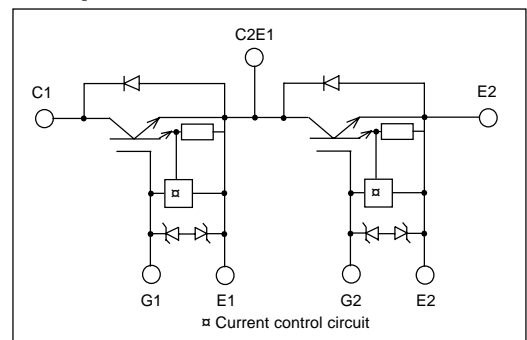

● Electrical characteristics (at $T_j=25^\circ\text{C}$ unless otherwise specified)

Item	Symbol	Characteristics			Conditions	Unit
		Min.	Typ.	Max.		
Zero gate voltage collector current	I_{CES}	–	–	1.0	$V_{GE}=0\text{V}$, $V_{CE}=600\text{V}$	mA
Gate-Emitter leakage current	I_{GES}	–	–	15	$V_{CE}=0\text{V}$, $V_{GE}=\pm 20\text{V}$	μA
Gate-Emitter threshold voltage	$V_{GE(th)}$	4.5	–	7.5	$V_{CE}=20\text{V}$, $I_c=150\text{mA}$	V
Collector-Emitter saturation voltage	$V_{CE(sat)}$	–	–	2.8	$V_{GE}=15\text{V}$, $I_c=150\text{A}$	V
Input capacitance	C_{ies}	–	9900	–	$V_{GE}=0\text{V}$	pF
Output capacitance	C_{oes}	–	2200	–	$V_{CE}=10\text{V}$	
Reverse transfer capacitance	C_{res}	–	1000	–	$f=1\text{MHz}$	
Turn-on time	t_{on}	–	0.6	1.2	$V_{CC}=300\text{V}$	μs
	t_r	–	0.2	0.6	$I_c=150\text{A}$	
Turn-off time	t_{off}	–	0.6	1.0	$V_{GE}=\pm 15\text{V}$	μs
	t_f	–	0.2	0.35	$R_G=16\text{ohm}$	
Diode forward on voltage	V_F	–	–	3.0	$I_F=150\text{A}$, $V_{GE}=0\text{V}$	V
Reverse recovery time	t_{rr}	–	–	0.3	$I_F=150\text{A}$	μs

● Thermal resistance characteristics

Item	Symbol	Characteristics			Conditions	Unit
		Min.	Typ.	Max.		
Thermal resistance	$R_{th(j-c)}$	–	–	0.21	IGBT	$^\circ\text{C/W}$
	$R_{th(j-c)}$	–	–	0.47	Diode	$^\circ\text{C/W}$
	$R_{th(c-f)*2}$	–	0.05	–	the base to cooling fin	$^\circ\text{C/W}$

*2 : This is the value which is defined mounting on the additional cooling fin with thermal compound

Characteristics (Representative)

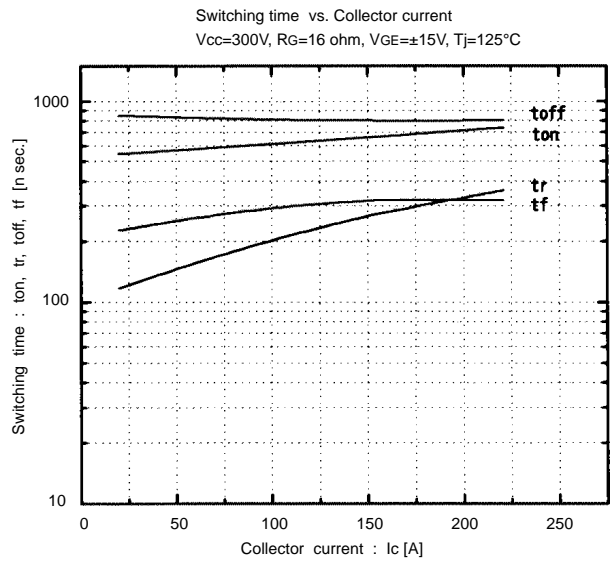
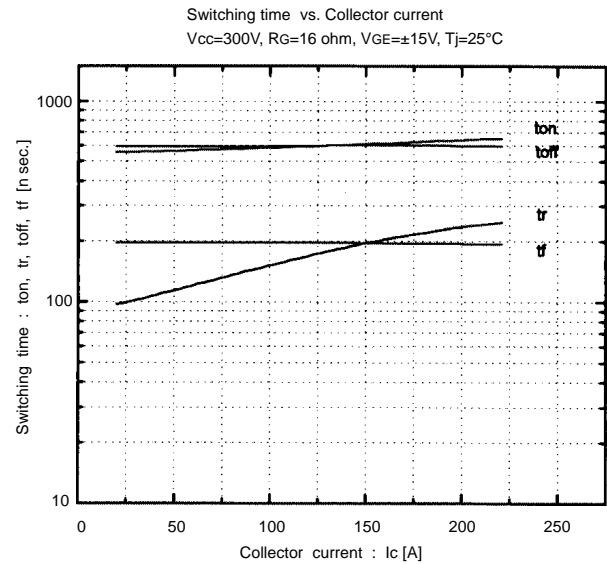
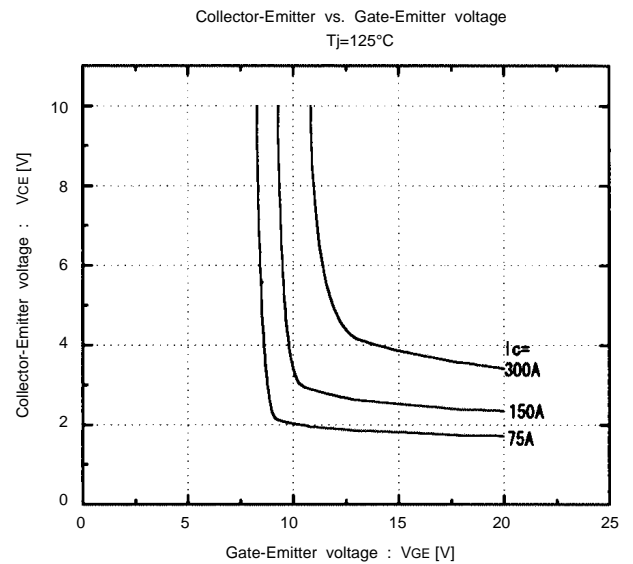
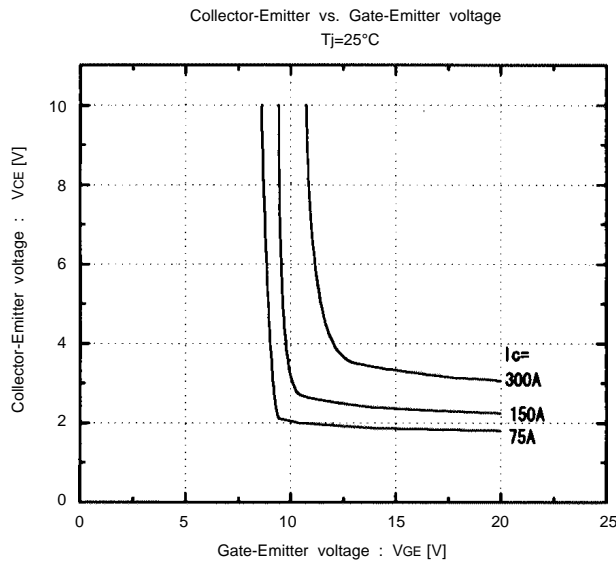
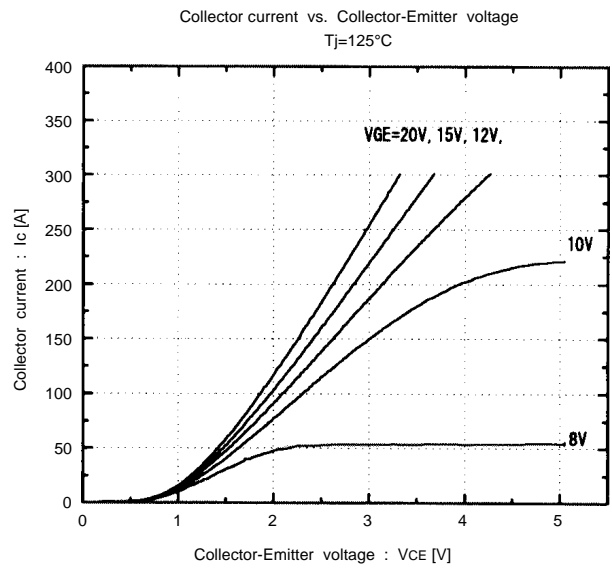
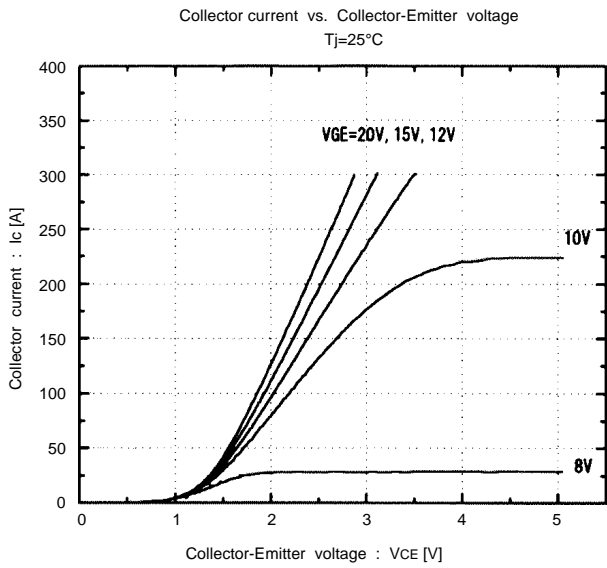

Switching time vs. R_G
 $V_{CC}=300V, I_c=150A, V_{GE}=\pm 15V, T_j=25^\circ C$

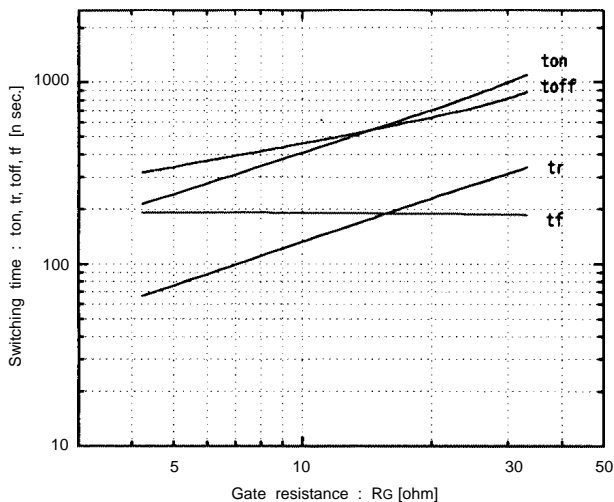

Dynamic input characteristics
 $T_j=25^\circ C$

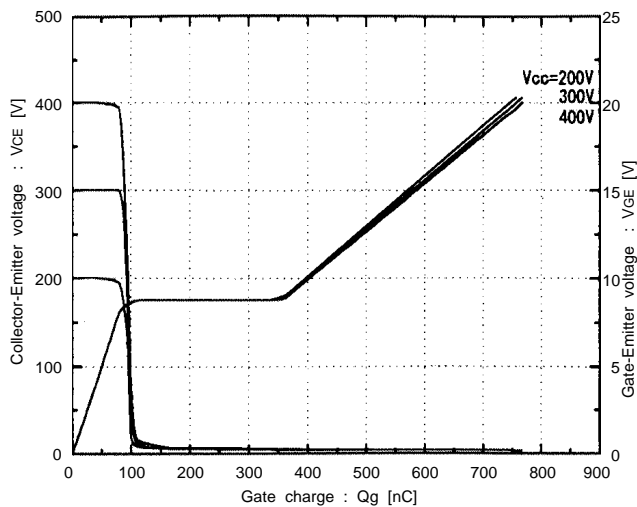

Forward current vs. Forward voltage
 $V_{GE}=0V$

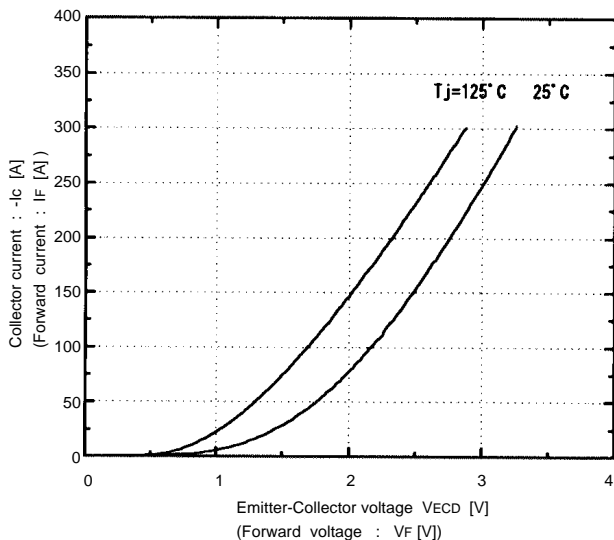

Reverse recovery characteristics
 t_{rr}, I_{rr} , vs. I_F

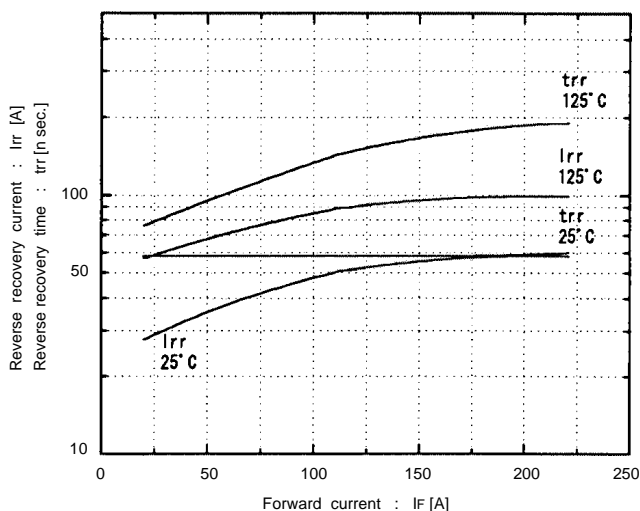

Switching loss vs. Collector current
 $V_{CC}=300V, R_G=16\text{ ohm}, V_{GE}=\pm 15V$

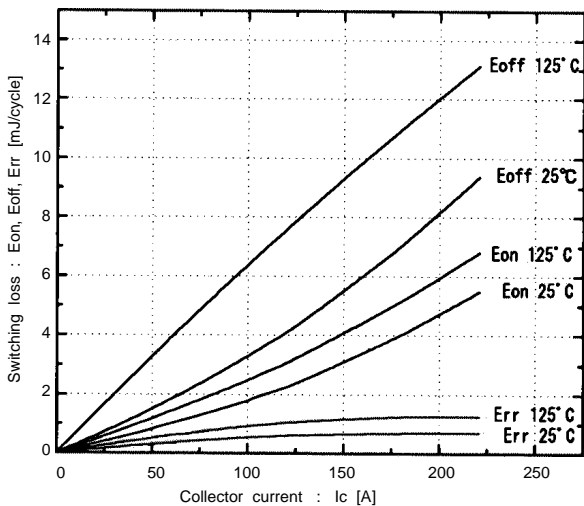

Reversed biased safe operating area
 $+V_{GE}=15V, -V_{GE} \le 15V, T_j \le 125^\circ C, R_G \ge 16\text{ ohm}$

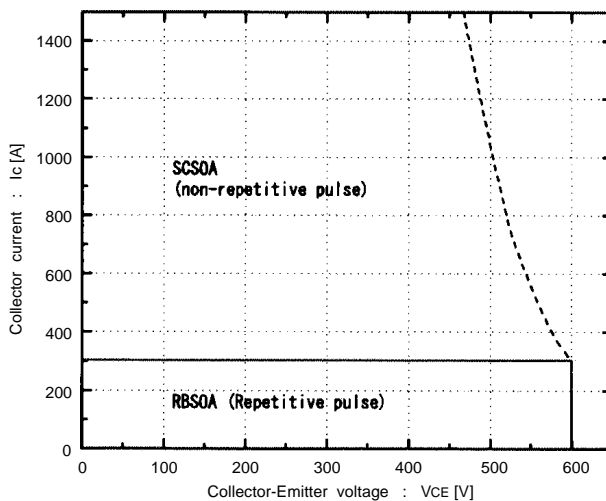

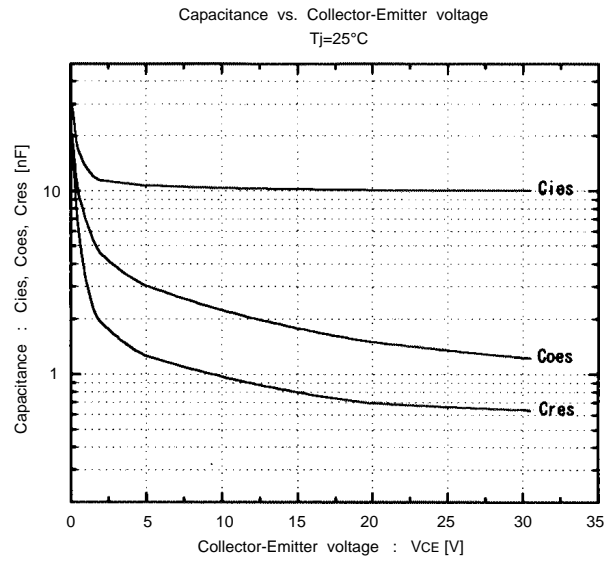
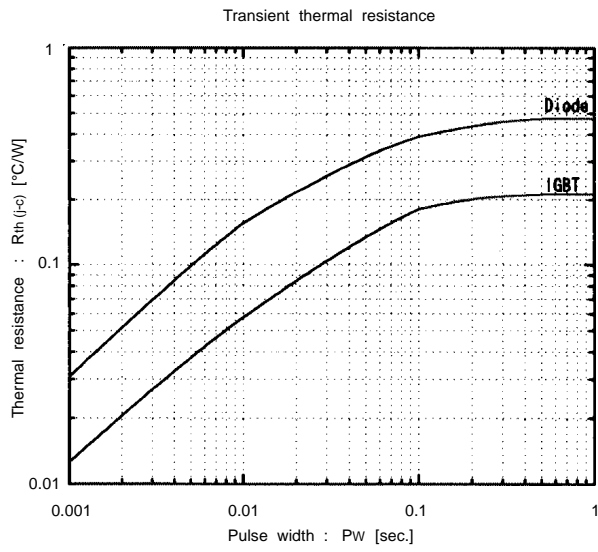

■ Outline Drawings, mm

